



1998 - 2003 CHEVY S-10 FLEET-SIDE (INCLUDING ZR-2) STD, EXT, 2WD, 4WD INSTALLATION INSTRUCTIONS - KIT #192

⚠WARNING

Installation of a Performance Accessories body lift will change the center of gravity and the handling characteristics of the vehicle. Because of the higher center of gravity and larger tires, the vehicle will handle and react differently both on and off road. You must drive it safely! Extreme care must be taken to prevent vehicle rollover or loss of control, which could result in serious injury or death. Avoid sudden sharp turns or abrupt maneuvers and always make sure all vehicle occupants have their seat belts fastened.

⚠WARNING

Read and understand all instructions, warnings, cautions, and notes in this sheet and in your owners manual before you begin the installation of this body lift kit.

⚠CAUTION

Proper installation of a Performance Accessories body lift kit requires knowledge of the factory recommended procedures for disassembly and assembly of original equipment components. We recommend that the factory shop manual and any special tools necessary to your vehicle be on hand during the installation. Installation of this body lift kit without proper knowledge of the factory recommended procedures may affect the performance of these components and the safety of your vehicle. We strongly recommend that a certified mechanic familiar with the installation of similar components install this body lift kit.

⚠WARNING

This body lift kit should only be installed on vehicles in good working condition. Before installation, the vehicle should be thoroughly inspected for evidence of corrosion or deformation of the sheet metal around the factory body mounts. This body lift kit should not be installed on any vehicle that is suspected to have been in a collision or misused. Off road use of your vehicle with this body lift installed may increase the stress applied to the factory body mounts. We do not recommend that any vehicle with a body lift installed be involved in any extreme off road maneuvers such as jumping. Failure to observe this warning may result in serious personal injury and/or severe damage to your vehicle.

⚠WARNING

Many states now have laws restricting bumper heights and vehicle lifts. Local laws should be consulted to determine if the changes you intend to make to your vehicle comply with state laws. Before combining a body lift with a suspension lift, consult an installation professional to see how this will affect your specific application.

⚠WARNING

The installation of larger wheel and tire combinations may reduce the effectiveness of the Anti-lock Braking System.

⚠WARNING

Always wear eye protection when operating power tools.

⚠WARNING

Ensure that your vehicle tires are properly blocked and secured before you begin installation of this lift kit.

⚠WARNING

The Supplemental Restraint System (SRS, or air bag) must be deactivated during lift kit installation to avoid accidental air bag deployment while working near SRS sensors and wiring. Do not allow anyone near the air bag during lift kit installation. Accidental deployment can result in serious personal injury or death. Refer to your factory service manual/owner's manual for the recommended procedure to disable the SRS. The SRS must be reactivated before driving the vehicle

⚠NOTE

Performance Accessories recommends using the Loctite® supplied in the kit on all hardware unless noted in the instructions.

A. Before you start.

⚠NOTE

As you read through this procedure, note that each part referenced has the same callout number throughout. Also, the part number in the text matches the corresponding part number in the art. Kit parts are prefaced by the word *kit* in italics.

⚠NOTE

You will find it easier to keep track of hardware if immediately after removal you put the fasteners for each subassembly in a paper lunch bag and write on the bag where they go.

1. Read all warnings and instructions completely and carefully before you begin.
2. Check to make sure the kit is complete (refer to the Parts List, section E).
3. Only install this kit on the vehicle for which it is intended. If anytime during the installation you encounter something different from what is outlined in the instructions, call technical support at (928) 636-0979.
4. Park the vehicle on a clean, dry, flat, level surface and block the tires so the vehicle cannot roll in either direction.
5. Disconnect both battery cables. Disconnect the negative cable (1) first, then the positive cable (2) from the battery (3).

⚠NOTE

Fuse locations may vary. Check fuse chart on back of cover.

6. Remove cover (4) and airbag fuse "SIR" (5) from fuse panel (6).

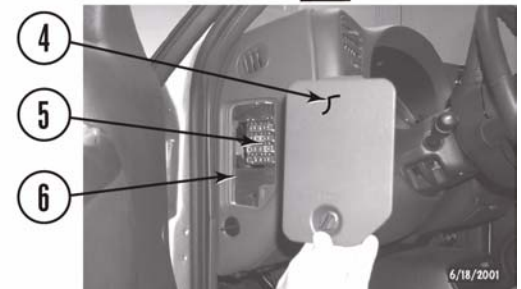
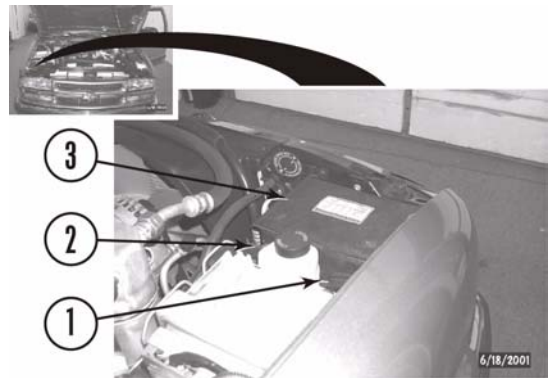

B. Get ready to install the kit.

1. Remove the grille.

- a. Remove ten pull clips (7) and grille (8) from core support (9).
- b. Remove two turn signal lamps (10) from turn signal housings (11).
- c. If so equipped, remove two wire harness connectors (12) from running lights (13). Remove grille from vehicle.

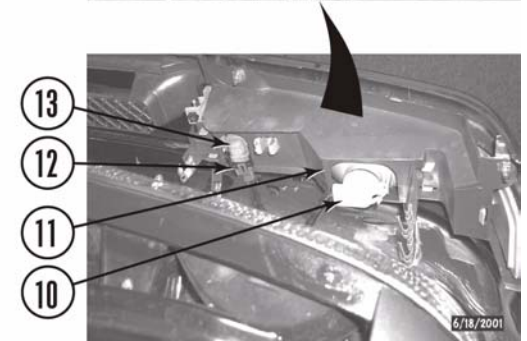
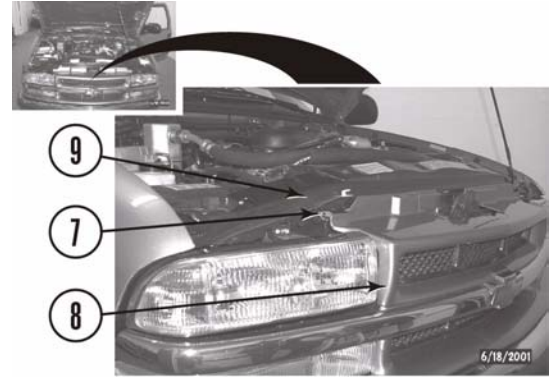

2. Remove the front bumper.

- a. Measure distance between the front bumper (14) and front fenders (15). Record measurement.
- b. Loosen two bolts (16) from front bumper side brackets (17) and front bumper (14).
- c. Remove four bolts (18) from front bumper side brackets (17) and frame (19).

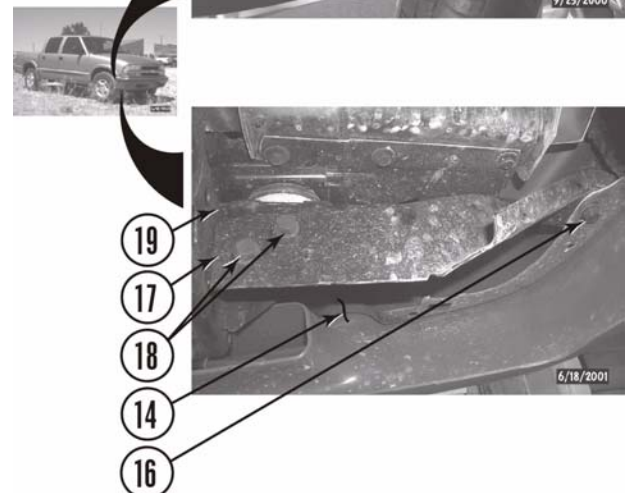
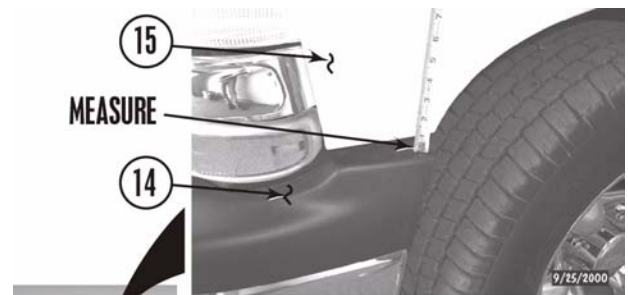

d. Remove four bolts (20) and front bumper (14) from frame (19).

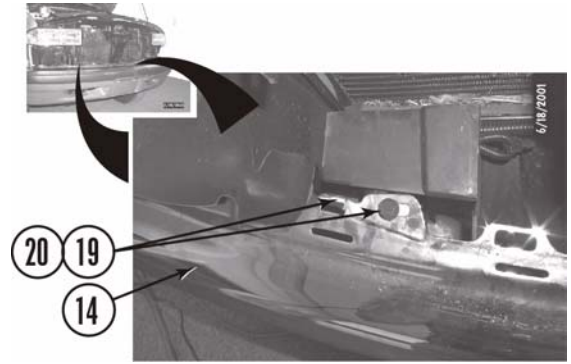

e. Remove four pull clips (21) and air scoop (22) from core support (9).

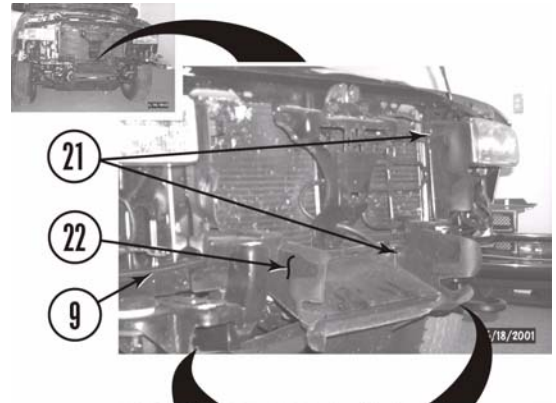

f. Remove four bolts (23) and two tow hooks (24) from frame (19).

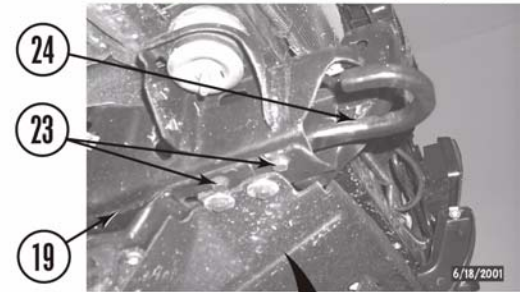

g. Remove six bolts (25), washers (26), and cover (27) from frame (19).

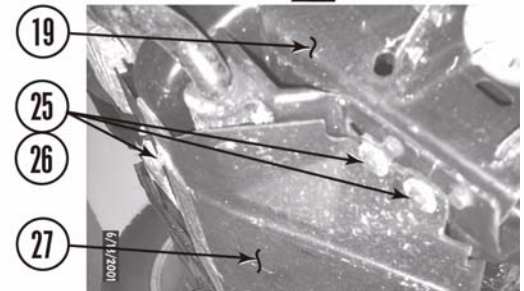

h. Remove two shoulder bolts (28) and oil filter bracket (29) from core support (9).

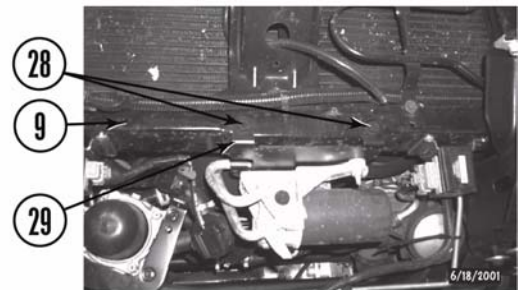

3. Under the hood.

- a. Remove vent hose (30) from clip (31) and upper fan shroud (32).

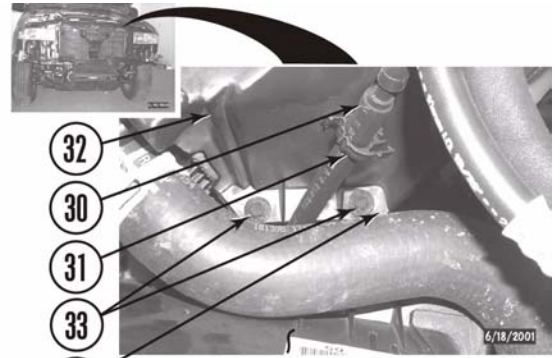

- b. Remove seven bolts (33) and upper fan shroud (32) from core support (9) and lower fan shroud (34).

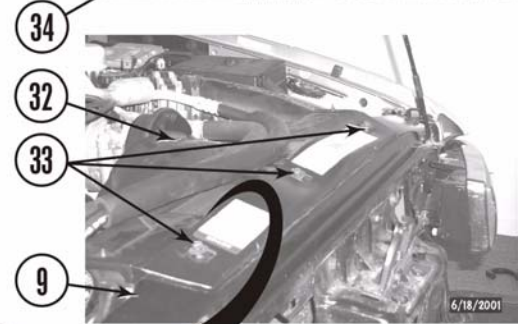

- c. Pull up on lower fan shroud (34) and remove from three clips on bottom of radiator (35). Let lower fan shroud rest under fan.

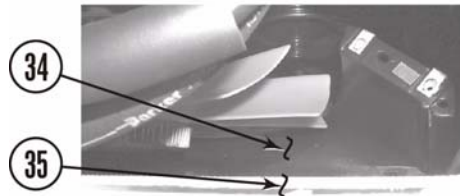

- d. Remove nut (36) and battery hold down (37) from battery tray (38). Remove battery (3) from vehicle.

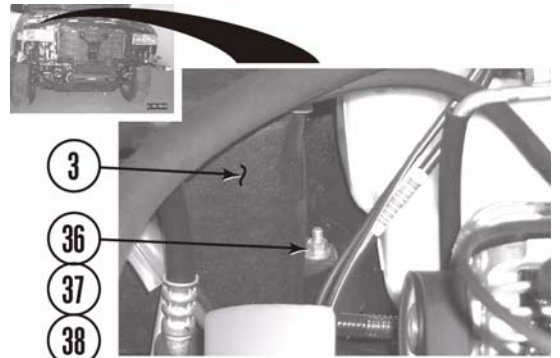

- e. On vehicles equipped with electrical ground strap (39) attached to frame (19), remove bolt (40) and ground strap from frame.

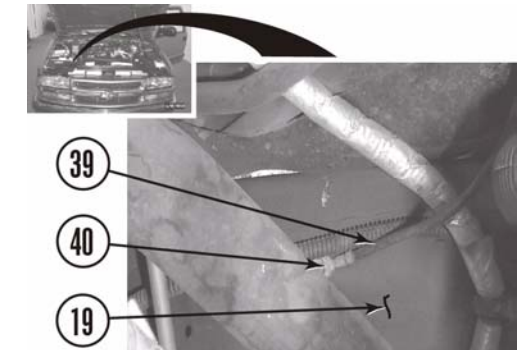

- f. Remove two bolts with captive washers (41) and battery tray (38) from core support (9).

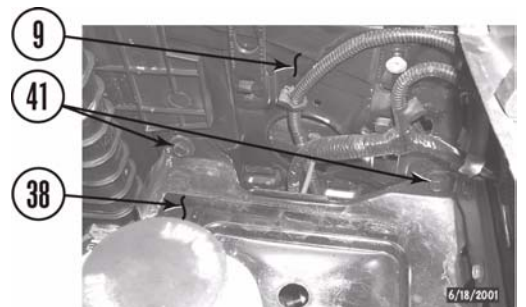

- g. If so equipped, cut zip tie (42). Remove clip (43) and positive cable terminal box (44) from bracket (45).

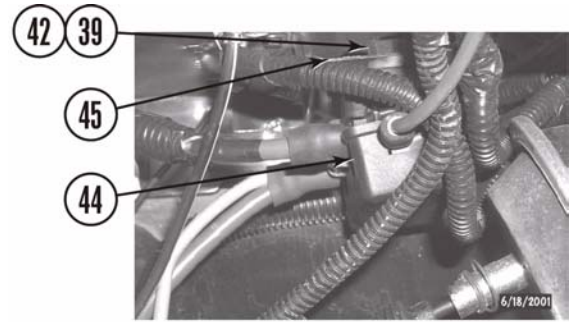

- h. Remove two sheet metal screws (46) and bracket (45) from core support (9).
- i. Remove two bolts with captive washers (47), differential actuator (48), and bracket (49) from passenger side wheel well (50).

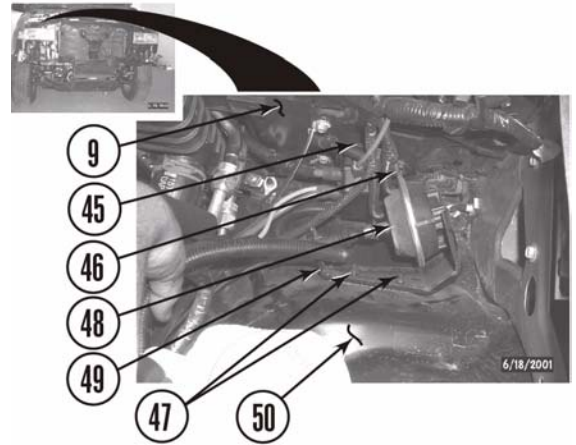

- j. Remove four screws (51) and loosen air filter housing cover (52) from air filter housing (53).

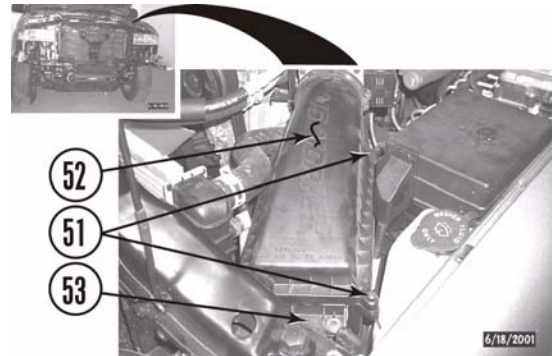

- k. Remove two wire clips (54), wire harnesses (55), wire harness clamp (56), and hose (57) from air intake housing (58).
- l. Remove thumb screw (59), air intake housing (58), and air filter housing cover (52) from throttle body (60) and air filter housing (58). Remove air filter (61) from filter housing.

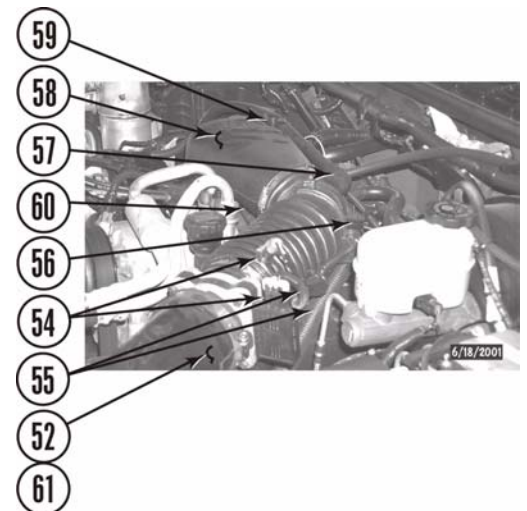

m. Remove nut (62) and air filter housing (53) from driver side wheel well (63).

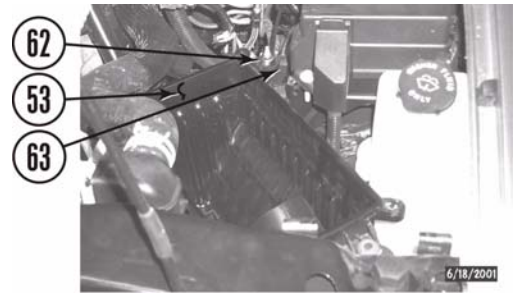

n. Remove nut (64) and ground strap (65) from fire-wall (66).

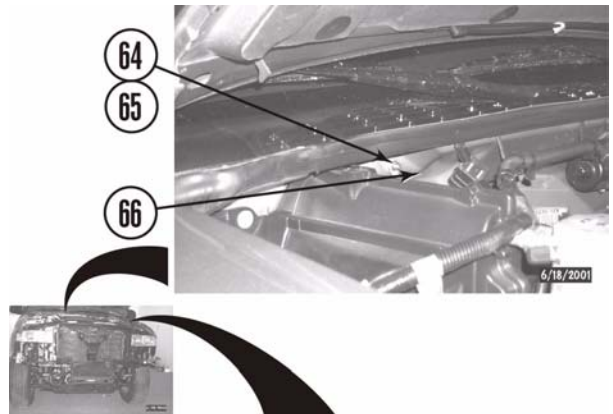

4. Along the frame rails.

a. Remove bolt (67), clip (68), and three brake lines (69) from driver side shock mount (70).

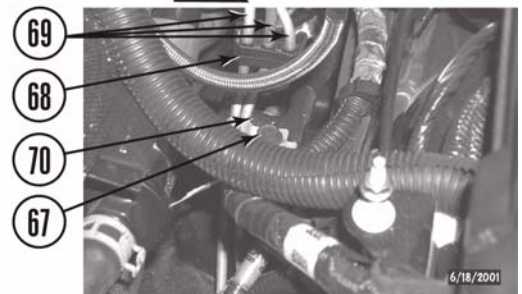

b. Remove push clip (71) and wire harness (72) from frame (19) driver side.

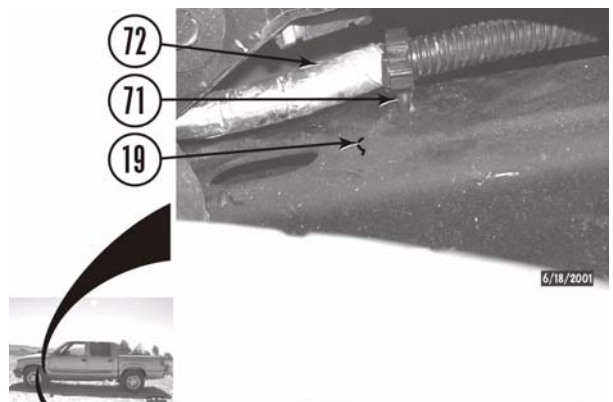

c. Remove plastic block (73) and brake line (74) from frame (19) driver side (it may be easier just to remove brake line).

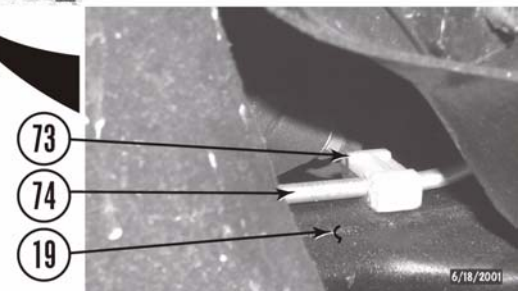

- d. Remove nut (75), two wire loom brackets (76), bolt (77), clamp (78), and two oil cooler lines (79) from oil pan (80).

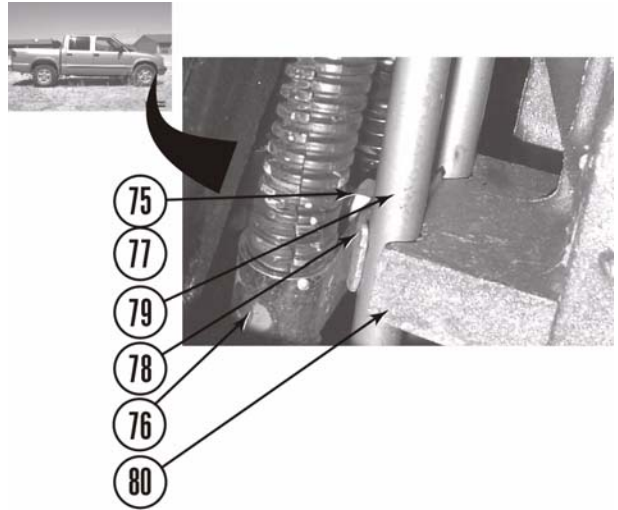

⚠WARNING

Use extreme caution when working near fuel lines and fuel tank. Clean up spilled fuel immediately. Any spark could cause an explosion or fire resulting in serious personal injury and property damage.

5. Fuel filler.

- a. Remove gas cap (81), three screws (82) and fuel filler (83) from bed (84).

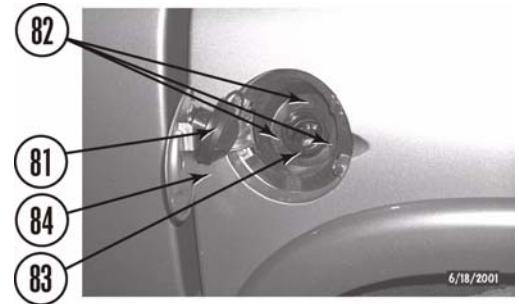

6. Rear bumper.

- a. Measure distance from the bed (84) to the rear bumper (85). Record measurements.
- b. Remove two screws (86) and license plate (87) from rear bumper (85).
- c. Remove two license plate lights (88) from bumper (85).

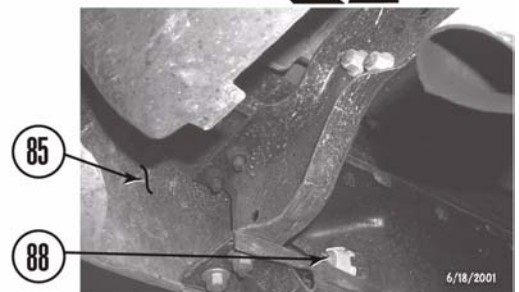
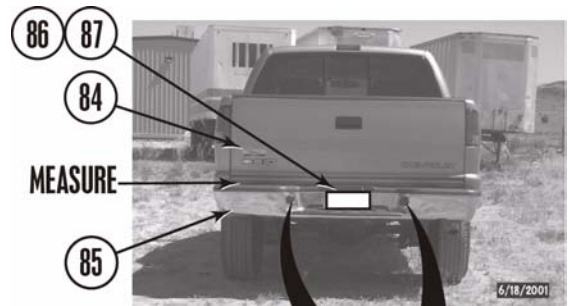

- d. Remove two wire harnesses (89) and clamps (90) from two rear bumper brackets (91) (some vehicles have only one harness clamp on driver side).

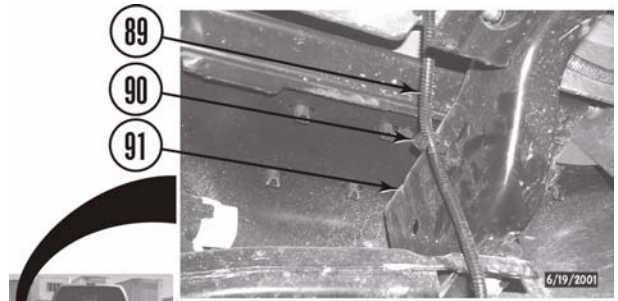

NOTE
Steps e. through f. are for vehicles equipped **without** OEM hitch. Other vehicles skip these steps.

- e. Remove six nuts (92) and bolts (93) from two rear bumper brackets (91) and frame (19).
- f. Remove two rear bumper brackets (91) and rear bumper (85) from frame (19).

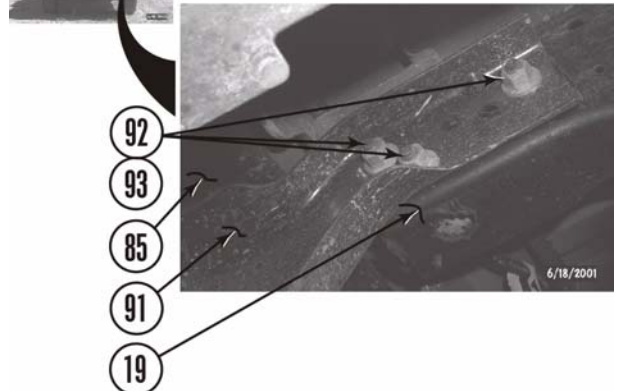

NOTE
Steps g. through k. are for vehicles equipped **with** OEM hitch. Other vehicles skip these steps.

- g. Remove two nuts (94), rectangular washers (95), and bolts (96) from frame (19) and two side hitch brackets (97).
- h. Remove four nuts (92) and bolts (93) from two side hitch brackets (97), rear bumper brackets (91), and frame (19).
- i. Remove six nuts (92), bolts (93), and hitch center (98) from two side hitch brackets (97). Remove two side hitch brackets from frame.
- j. Remove four nuts (92) and six bolts (93 and 99) from two rear bumper brackets (91) and frame (19).
- k. Remove two rear bumper brackets (91) and rear bumper (85) from frame (19).

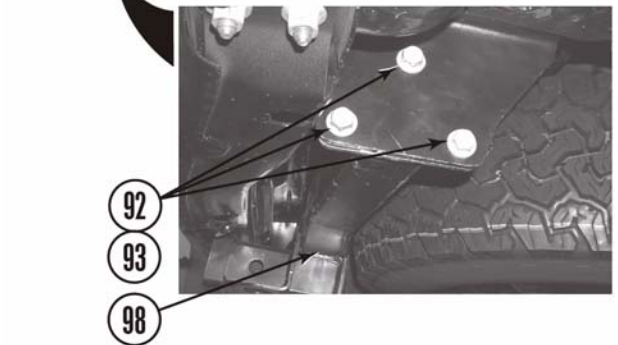
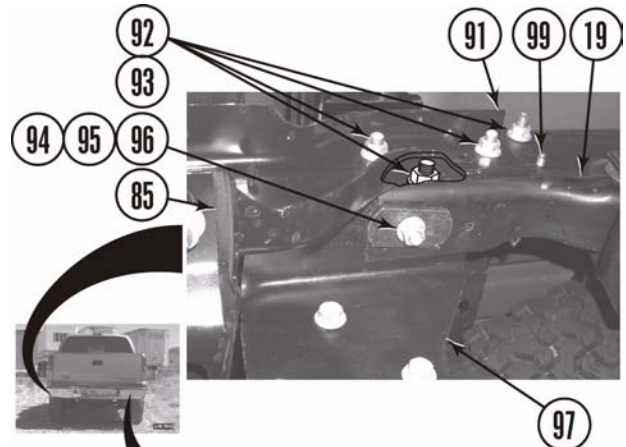

7. Manual transmission - remove shift lever.

NOTE

Steps 7. through 9. are for manual transmission vehicles only. Automatic transmission/transfer case vehicles skip these steps.

- a. Shift transmission extension shift lever (100) into neutral.
- b. Remove four screws (101) from boot (102) and console (103) and slide boot up on transmission extension shift lever (100).
- c. Unscrew transmission extension lever (100) from shift tower lever (104).
- d. Remove four bolts (105) and shift tower (106) from transmission (107).
- e. Remove rubber cover (108) from shift tower (106).
- f. Remove four screws (109), plate (110), and shim(s) (111) from shift tower (106).
- g. Remove shift tower lever (104) from shift tower (106).
- h. Remove two plastic shift tabs (112) and plastic ball end locator (113) from shift tower lever end (114).

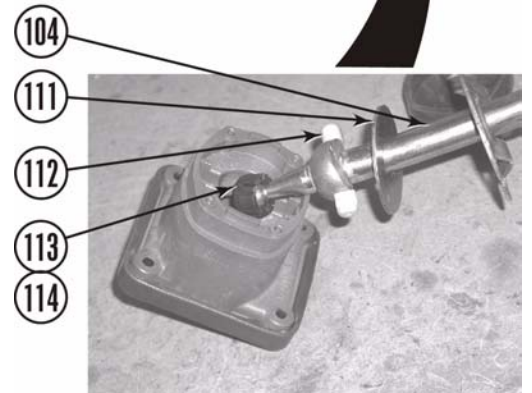
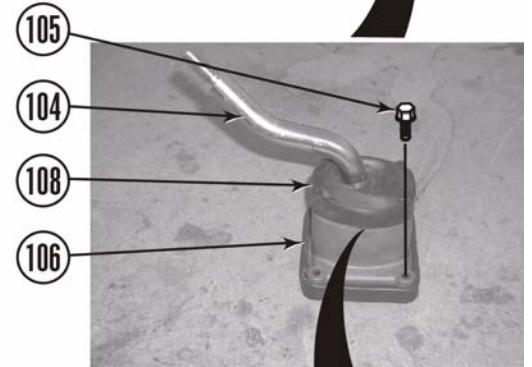
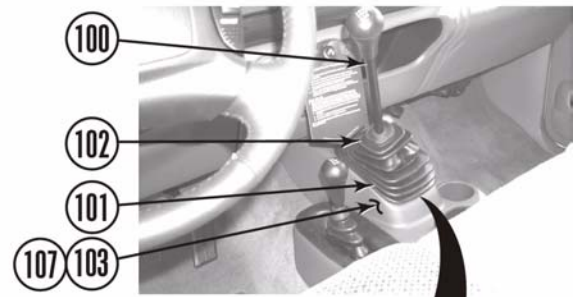

WARNING

Be careful not to damage any of the parts attached to the shift levers during cutting and welding or damage to the equipment could result. A certified welder should perform all welding.

8. Lengthen transmission shift lever.

- a. Scribe a line along the side of the shift tower lever (104) (below the lowest bend) as shown. Cut the lever into two pieces through the line and deburr as necessary.
- b. Position *kit* shift lever extension (115) between the two pieces of the shift tower lever (104). Ensure the extension and lever scribed lines align and weld the extension in place.

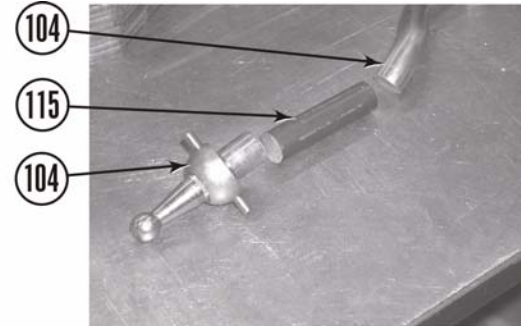

9. Install transmission shift lever.

- a. Install two plastic shift tabs (112) on shift tower lever (104) and plastic ball end locator (113) on shift tower lever end (114).
- b. Install shim(s) (111) and plate (110) on shift tower (106) with four screws (109).
- c. Install rubber cover (108) on shift tower (106).
- d. Install shift tower (106) on transmission (107) with four bolts (105).
- e. Install transmission extension lever (100) on shift tower lever (104).
- f. Install boot (102) on console (103) with four screws (101).
- g. Check transmission shift lever operation. Ensure there is complete engagement in all gears.

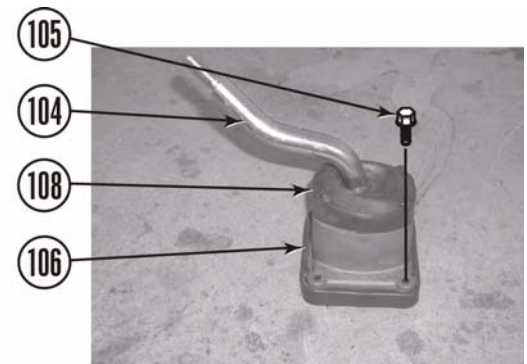
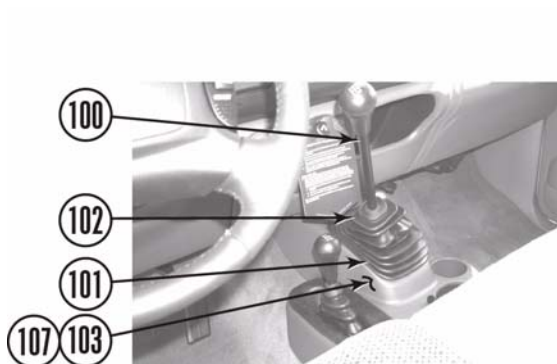
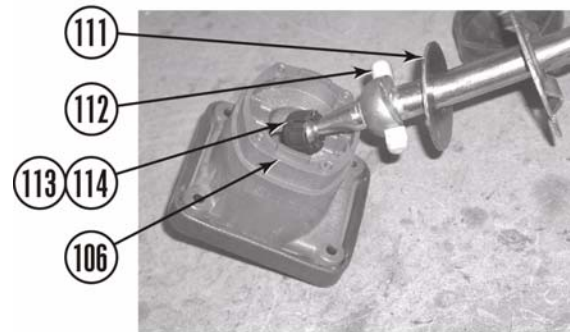

C. Install the kit.

1. Measure the distance between the cab (115) and bed (84). Record measurement for later cab to bed alignment reference in these instructions.
2. Prepare to lift body from frame.

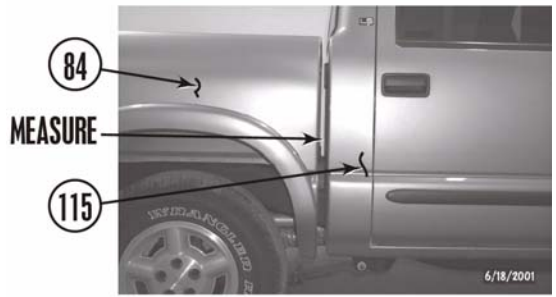

⚠WARNING
 Failure to replace the OEM body mounting hardware (except mounting bolts in the kit) in the stock locations could result in serious personal injury or damage to the vehicle.



- a. Hold two core support bolts with captive washers (116) and loosen but do not remove two nuts (117).
- b. Loosen but do not remove six body mounting bolts (118).

⚠WARNING
 Use extreme caution when lifting body from frame. Ensure lifting device is securely placed. Keep hands out from between frame and body, or serious personal injury could result.

⚠CAUTION
 Continually check hoses, wires, lines, etc. to be sure that everything is flexing properly and not binding, or damage to the vehicle could result. Be especially careful of the a/c hoses at the fire wall, the belt pulley, and at the core support. Ensure brake lines stretch while lifting. Bending the lines to gain ample slack may be necessary. Be extremely careful not to kink the lines.

⚠NOTE
 Ensure stock spacers and body mounting pads stay on vehicle unless otherwise specified in these instructions. *Kit* spacer blocks are installed in addition to the stock spacers and body mounting pads.

- c. Remove nut (117), bottom bushing retaining cup (119), bottom bushing (120), and bolt with captive washer (116) from frame mounting pad (121) and core support (9).
- d. Remove three passenger side body bolts (118), bottom bushing retaining cups (119), and bottom bushings (120) from frame mounting pads (121) and cab floor (122).

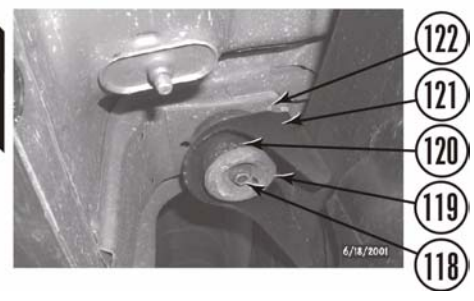
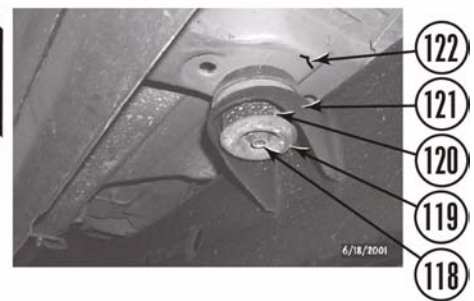
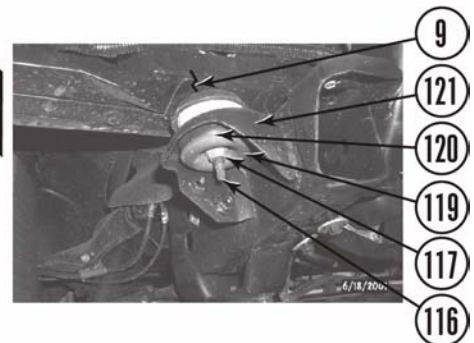

⚠WARNING

Continually check hoses, wires, lines, etc. to be sure that everything is flexing properly and not binding, or damage to the vehicle could result. **Be especially careful of the ABS lines on top of the driver side wheel well. Bending the lines a little at a time while lifting may be necessary. Be extremely careful not to kink the lines.**

3. Lift body and install body passenger side *kit* spacer blocks.
 - a. Using a hydraulic jack and a wooden block, slowly lift body (115) passenger side just high enough to position *kit* 2" x 3" spacer block (123) between top bushing retaining cup (124) and core support (9).
 - b. Position three *kit* 2" x 3" spacer blocks (123) on top of the passenger side top bushing retaining cups (124).
 - c. Install a *kit* 12mm x 140mm bolt (125) through *kit* 7/16" USS washer (126), core support (9), *kit* spacer block (123), top bushing retaining cup (124), top bushing (127), frame mounting pad (121), bottom bushing (120), bottom bushing retaining cup (119), and nut (117). Do not tighten.
 - d. Install three *kit* 12mm x 140mm bolts (125) through three *kit* 7/16" USS washers (126), bottom bushing retaining cups (119), bottom bushings (120), frame mounting pads (121), top bushings (127), top bushing retaining cups (124), *kit* spacer blocks (123), and cab floor (122). Do not tighten.
 - e. Lower cab (115) onto *kit* spacer blocks (123).

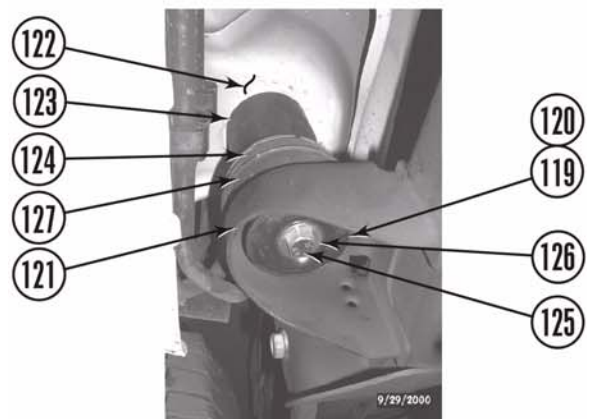
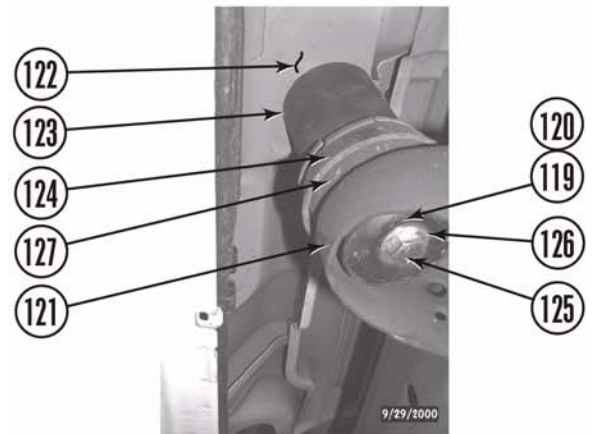
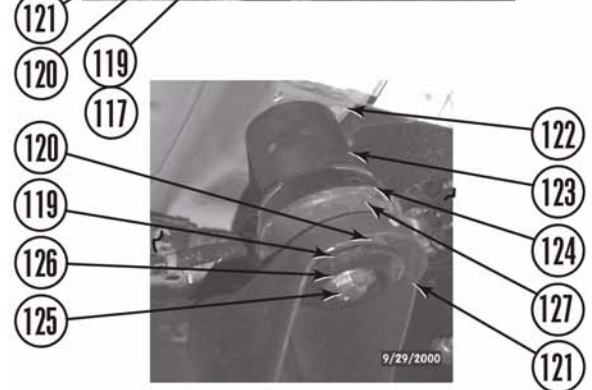
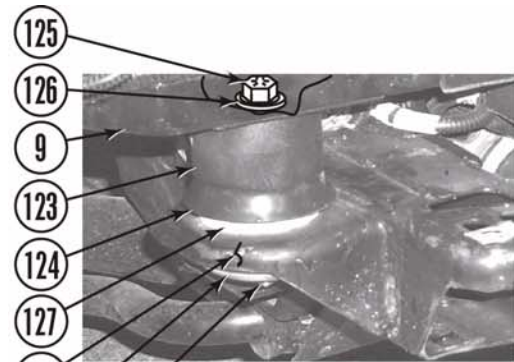

4. Install the body driver side spacer blocks.
 - a. Repeat steps C.3.a. through C.3.e. for the body driver side.
5. Finish the body spacer block installation.
 - a. Remove eight *kit* bolts (125) one at a time, coat threads with Loctite®, and reinstall. Tighten until bottom bushing retaining cup bottoms out.

6. Lift truck bed and install passenger side *kit* spacer blocks.

a. Remove eight bolts with captive washers (128) from frame (19) and bed (84).

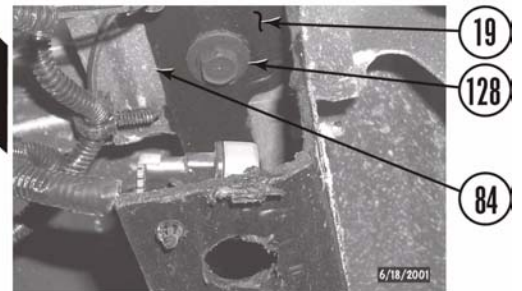
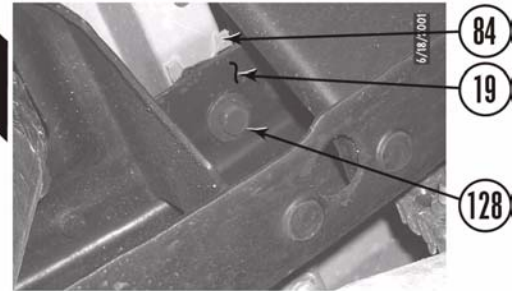
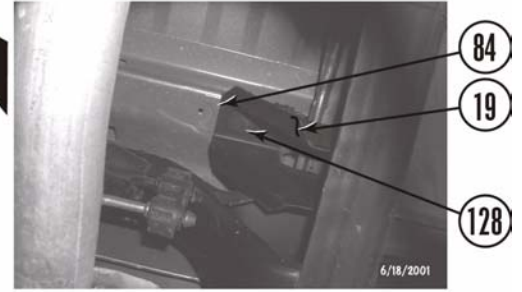

- b. Reposition bed (84) away from cab (115) as shown to access fuel hose assembly (129) under rear of cab.

⚠WARNING

Use extreme caution when working near fuel lines and fuel tank. Clean up spilled fuel immediately. Any spark could cause an explosion or fire resulting in serious personal injury and property damage.

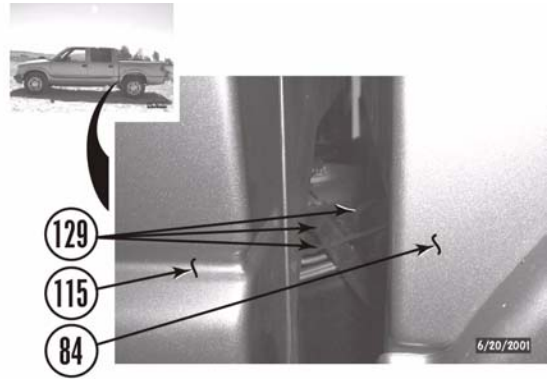

7. All models except 2003 ZR-2.

- a. Remove bolt (130) and ground strap (131) from frame (19).
- b. Remove two hose clamps (132), vent hose (133), fuel hose (134), and fuel hose assembly (129) from gas tank (135) and vehicle.

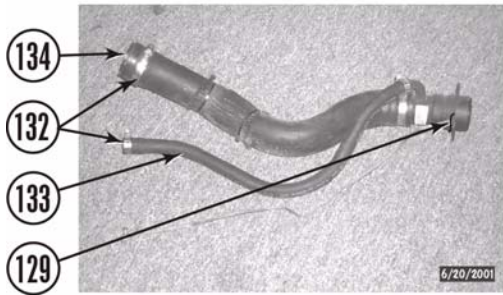
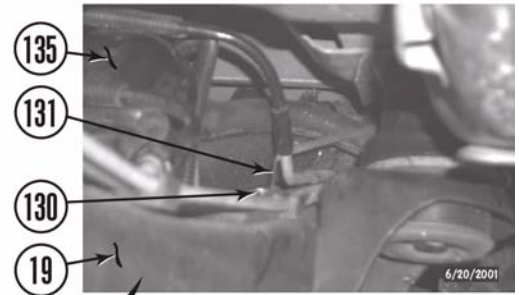

- c. Cut fuel hose (134) as shown and install *kit 2"* fuel extension (136) with two *kit #36* hose clamps (137).
- d. Cut vent hose (133) as shown and install *kit 11/16"* vent hose extension (138) with two *kit #10* hose clamps (139).
- e. Install fuel hose (134) and vent hose (133) on fuel tank (135) with two hose clamps (132).
- f. Install ground strap (131) on frame (19) with bolt (130).

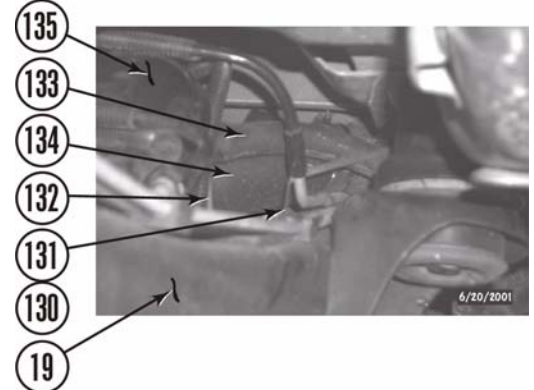
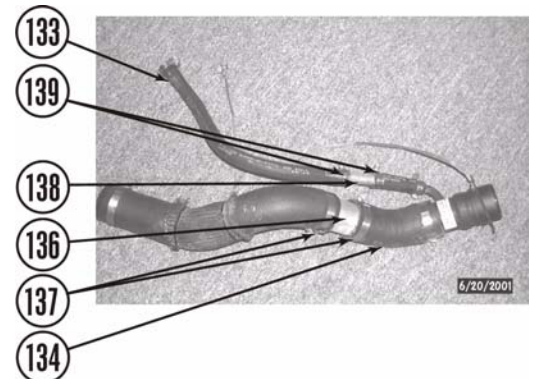

8. **2003 ZR-2 Fuel lines only.**

- a. Remove bolt (130) and ground strap (131) from frame (19).
- b. Remove hose clamp (132) and fuel hose assembly (140) from gas tank (135) and vehicle.

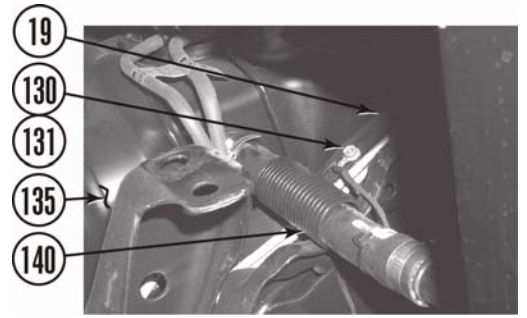

- c. Cut fuel hose (141) as shown and install *kit* 1" fuel extension (142) with two *kit* #28 hose clamps (143).

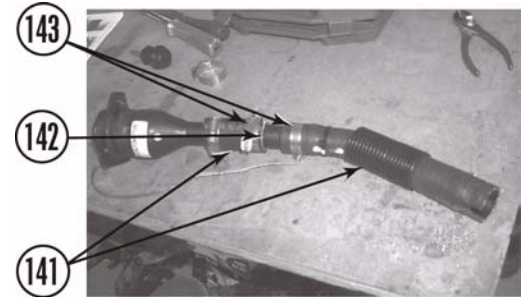

- d. Install fuel hose assembly (140) on gas tank (135) with hose clamp (132).

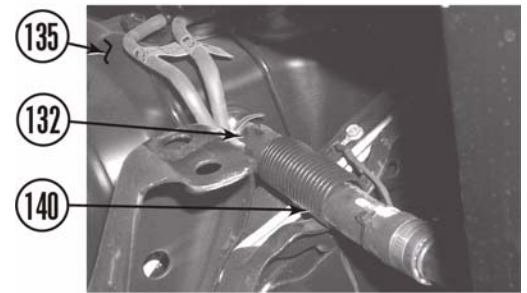

9. Install fuel filler (83) on bed (84) with three screws (82). Install gas cap (77) on fuel filler.

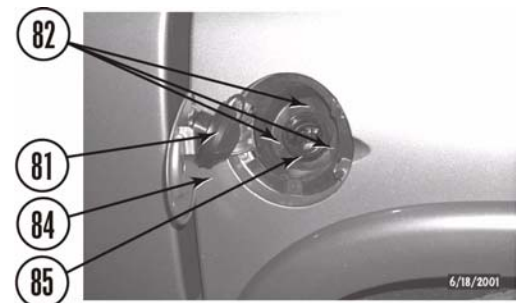

- a. Reposition bed (84) on frame (19). Install any two bolts (128) through frame and bed on driver side. Do not tighten.



10. Lift passenger side.

- a. Using a hydraulic jack and a wooden block, slowly lift the bed (84) passenger side just high enough to position the *kit* spacer blocks (144 and 123) between the bed and frame (19).
- b. Position three *kit* 2" x 2" spacer blocks (144) on three forward frame mounting pads (145) (some models may only have two forward frame mounting pads).
- c. Position *kit* 2" x 3" block (123) on rear frame mounting pad.
- d. Install four *kit* 10mm x 80mm bolts (146) through *kit* 3/8" USS washers (147), frame mounting pads (145), *kit* spacer blocks (144 and 123), and bed (84). Do not tighten.
- e. Lower bed (84) onto *kit* spacer blocks (144 and 123).

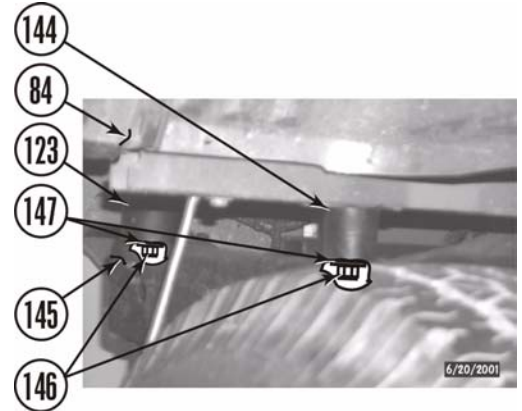

11. Install driver side bed blocks.

- a. Repeat steps ***C.6.j. through C.6.n. for the bed driver side.

12. Finish bed spacer block installation.

- a. Adjust bed (84) to cab (115) clearance using measurements taken in step B.5.f.
- b. Remove eight *kit* bed mounting bolts (146) one at a time, coat threads with Loctite®, and reinstall. Tighten to 55 lb-ft.

13. **2003 ZR-2 only** - Reposition spare tire winch access tube.

- a. Position *kit* conduit clamp (148) over spare tire winch access tube (149) against spare tire shoe (150) as shown. Ensure a 1/8" - 3/16" gap between tube and bed (84). Mark and drill a 5/16" hole through shoe.
- b. Install *kit* conduit clamp (148) on spare tire shoe (150) with *kit* 1/4" x 1" bolt (151), two *kit* 1/4" SAE washers (152), and *kit* 1/4" nylock nut (153).

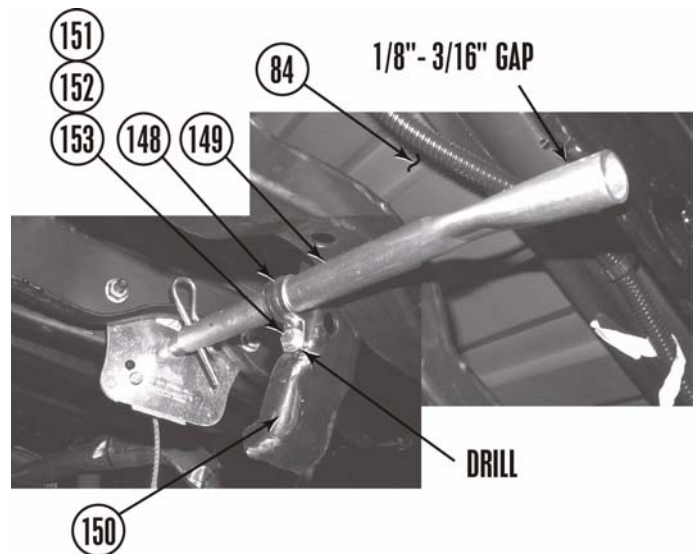

⚠WARNING

The following procedure is intended only to enhance the appearance of the vehicle. The rear bumper will no longer be rated for towing of any kind. Towing with the rear bumper after it has been lifted can result in death, serious personal injury, or damage to the vehicle. Towing after the bumper has been lifted should be accomplished using a rated Class III receiver type hitch.

14. Install the rear bumper.

- a. Squeeze 18 plastic clips (154) one at a time and remove plastic bumper cover (155) from rear bumper (85).

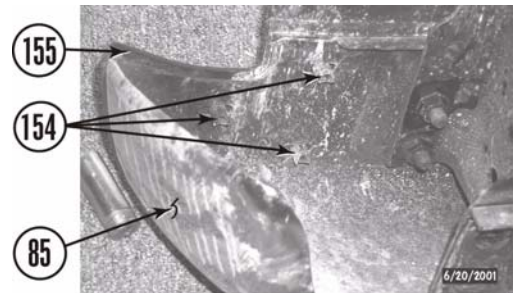

- b. Remove four nuts with captive washers (156) and two double studs (157) from bumper brackets (91) and rear bumper (85).

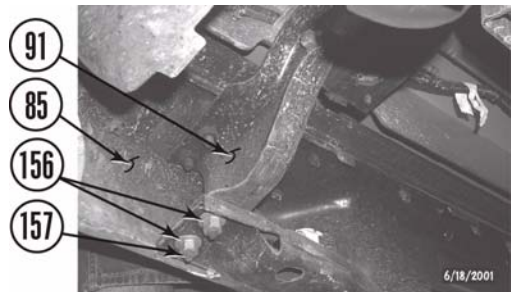

- c. Remove four bolts with captive washers (158) and rear bumper brackets (91) from rear bumper (85).



- d. Install two *kit* rear bumper brackets (159) on rear bumper (85) with four bolts with captive washers (158), four *kit* 1/2" USS washers (160), four *kit* 14mm nylock nuts (161), two double studs (157), and four nuts with captive washers (156). Do not tighten.

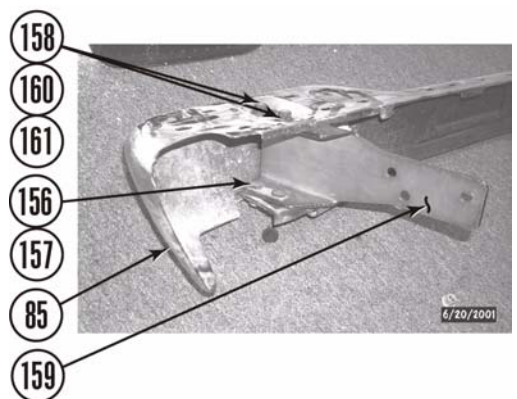

- e. Position two *kit* rear bumper brackets (159) and rear bumper (85) on frame (19).

NOTE

Steps 12.f. through 12.i. are for vehicles equipped **with** OEM hitch. Other vehicles skip these steps.

- f. Position two side hitch brackets (97) on *kit* rear bumper brackets (159) and frame (19). Install two side hitch brackets and two *kit* rear bumper brackets on frame (19) with six bolts (93 and 99) and four nuts (92). Do not tighten.
- g. Install hitch center (98) on two side hitch brackets (97) with six bolts (93) and nuts (92). Do not tighten.
- h. Install four bolts (93) and nuts (92) in two side hitch brackets (97), *kit* rear bumper brackets (159) and frame (19). Do not tighten.
- i. Install two side hitch brackets (97) on frame (19) with two bolts (96), rectangular washers (95), and nuts (94). Do not tighten.

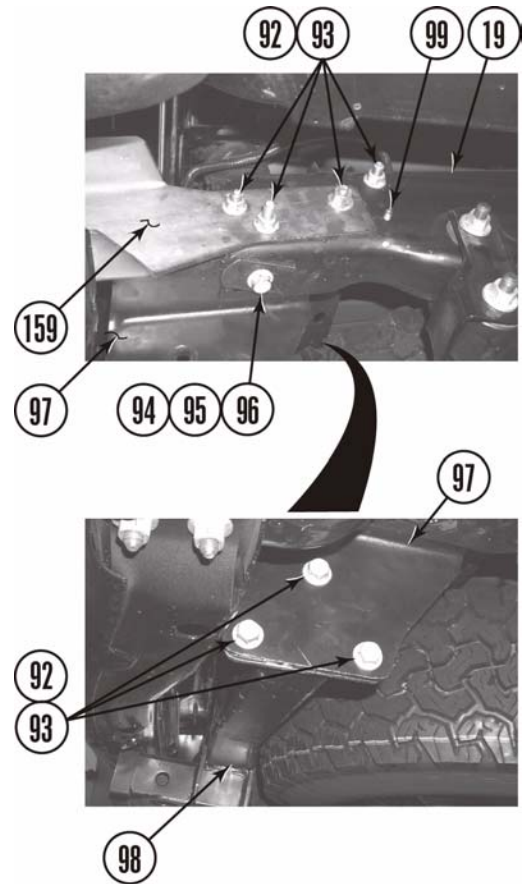
**NOTE**

Step 12.j. is for vehicles equipped **without** OEM hitch. Other vehicles skip these steps.

- j. Install two *kit* rear bumper brackets (159) on frame (19) with six bolts (92) and nuts (93). Do not tighten.
- k. Install two license plate lights (88) on rear bumper (85).
- l. Adjust rear bumper (85) to bed (84) clearance using measurements taken in step **B.6.a. Tighten nuts (92 and 94) and bolts (93 and 96) to 55 lb-ft.
- m. Using a 7/8" hole saw, drill a spare tire winch access hole in the rear bumper (85) as shown.

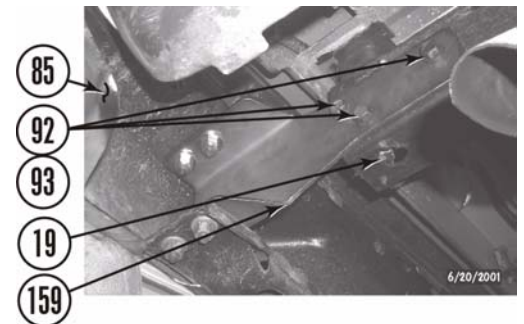

- n. Install plastic bumper cover (155) on bumper (85).
- o. Install license plate (87) on rear bumper (85) with two screws (86).

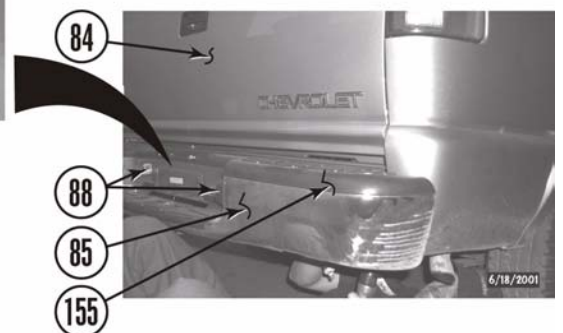

15. Along the frame rails.

- a. If possible, install plastic block (73) and brake line (74) on frame (19).
- b. If possible, install push clip (71) and wire harness (72) on frame (19).

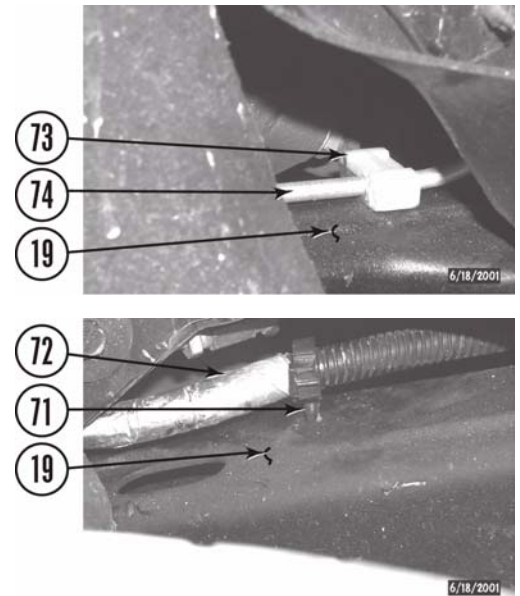

16. Under the hood.

- a. Drill two 1/8" holes in core support (9) 1/2" toward center of vehicle from old holes as shown. Install bracket (45) on core support with two sheet metal screws (46) in the new holes.
- b. Install positive battery cable box (44) on bracket (45).
- c. Check to see if differential activator (48) and bracket (49) will mount easily in original holes. If not, drill two 11/32" holes in wheel well (50) 1/2" toward center of vehicle from old holes as shown.

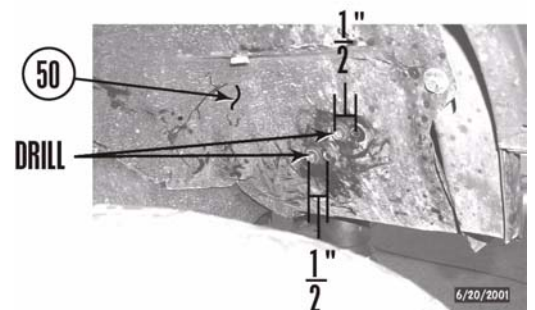
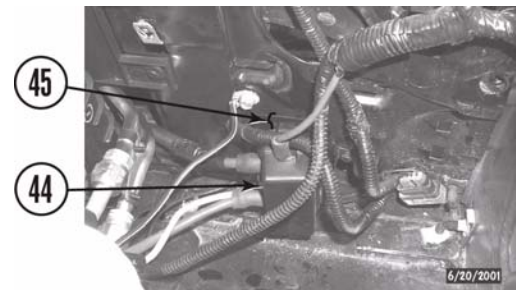
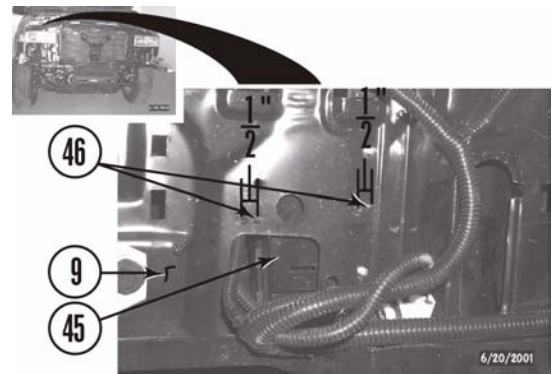

d. Install differential actuator (48) and bracket (49) on wheel well (50) with two bolts with captive washers (47).

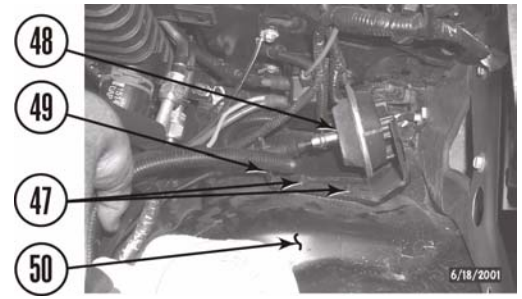

e. If electrical ground strap (39) was removed in step B.3.e., install electrical ground strap on *kit* ground bracket (162) with *kit* 1/4" x 1" bolt (151), two *kit* 1/4" SAE washers (152), and *kit* 1/4" nylock nut (153).

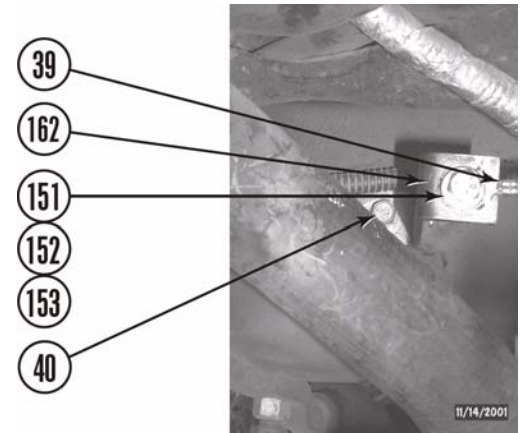

f. Install *kit* ground bracket (162) on frame (19) with bolt (40).

g. Install battery tray (38) on core support (9) with two bolts with captive washers (41).

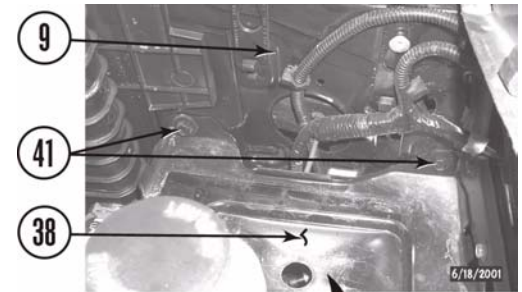

h. Install battery (3) on battery tray (38) with battery hold down (37) and nut (36).

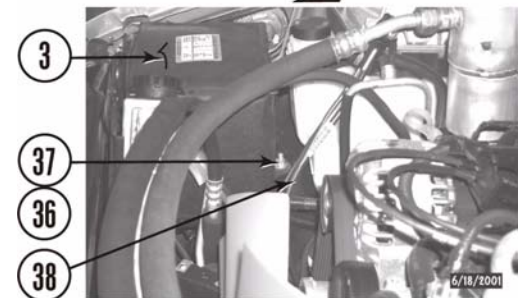

i. Install *kit* bracket (163) on firewall (66) with nut (64).

j. Install ground strap (65) on *kit* bracket (163) with *kit* 1/4" x 1" bolt (151), two *kit* 1/4" washers (152), and *kit* 1/4" nylock nut (153).

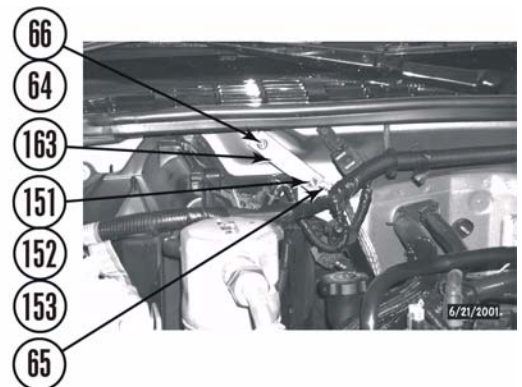

NOTE

You may find it easier to install the fan shroud before installing the air filter housing.

- k. Install air filter housing (53) on wheel well (63) with nut (62).

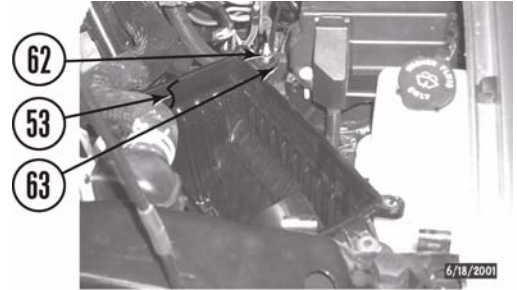

- l. Install air filter (61) in air filter housing (53). Install air filter housing cover (52) on air filter housing with four screws (51).

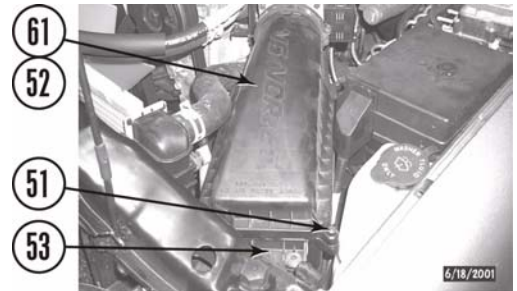

- m. Install air intake housing (58) on throttle body (60) with thumb screw (59).

- n. Install two wire clips (54), wire harnesses (55), wire harness clamp (56), and hose (57) on air intake housing (58).

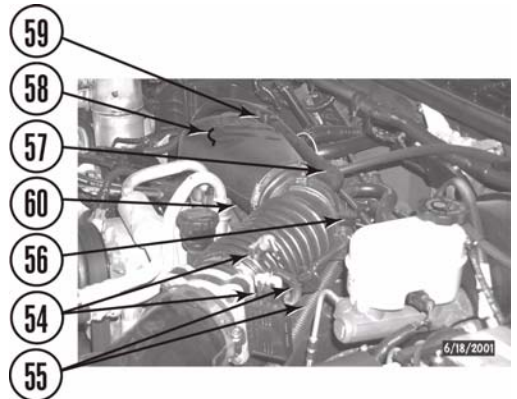
**17. Radiator.**

- a. Remove four clip nuts (164) from lower fan shroud (34).

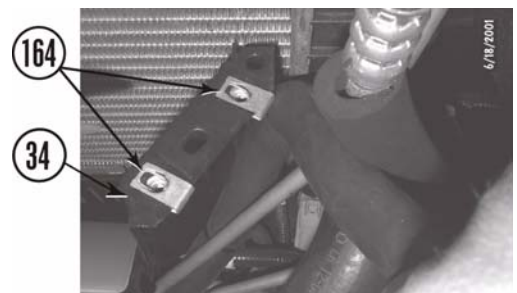

- b. Install upper fan shroud (32) on core support (9) with three bolts with captive washers (33).

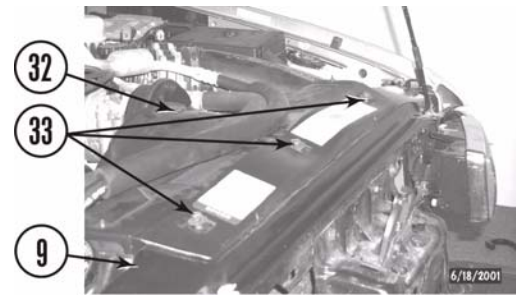

- c. Install upper fan shroud (32) on lower fan shroud (34) with four *kit* 3/8" USS washers (165), four *kit* 3/8" x 3 1/2" bolts (166), four *kit* tubes (167), four *kit* 3/8" USS washers (168), and four *kit* 3/8" nylock nuts (169).

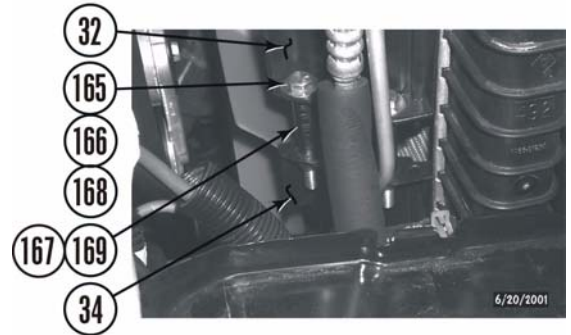

- d. Install *kit* lower fan shroud bracket (170) on lower fan shroud (34) behind middle clip (171).

- e. Using *kit* lower fan shroud bracket (170) as a template mark core support as shown and drill 1/8" hole in core support (9). Install *kit* lower fan shroud bracket on core support with *kit* sheet metal screw (172).

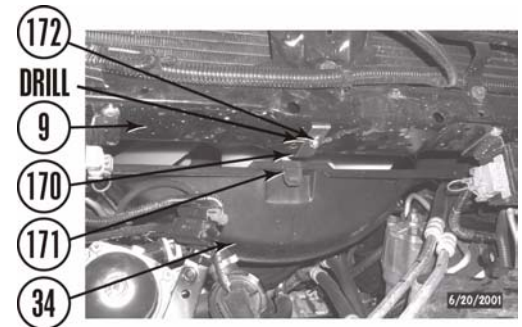

- f. Install *kit* zip tie (173) on upper hard line (174) and lower hard line (175). Ensure hard lines do not contact lower radiator hose (176).

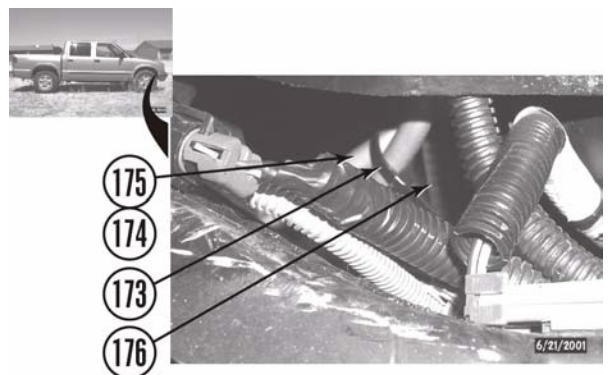

NOTE

2001 up vehicles turn *kit* front oil filter bracket around to install.

- g. Install *kit* front oil bracket (177) and *kit* rear oil bracket (178) on oil filter bracket (29) with two shoulder bolts (28) (rear oil bracket has notch in top side). Do not tighten.
- h. Install *kit* front oil bracket (177) and *kit* rear oil bracket (178) on core support (9) with two *kit* 1/2" x 3" shoulder bolts (179), two *kit* 3/8" USS washers (168), and two *kit* 3/8" nylock nuts (169). Tighten nuts (169) and bolts (28, 168, and 179) to 55 lb-ft.
- i. Install cover (27) on frame (19) with six washers (26) and six bolts (25).

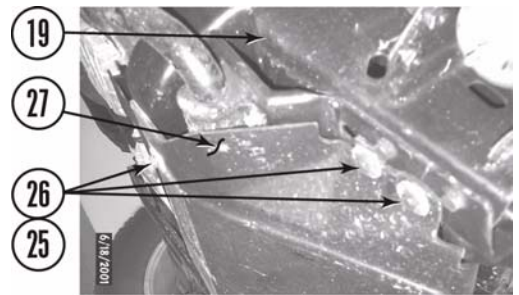
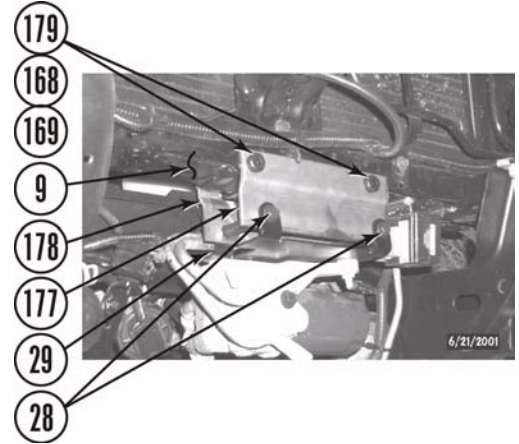
**NOTE**

For 2003 ZR-2, skip Step 16. below.

18. Install the front bumper.
- a. Trim valence (180) to accommodate frame as shown.
 - b. Position four *kit* 2" x 2" spacer blocks (144) on frame (19).

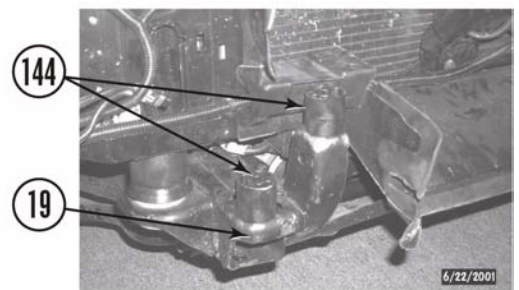
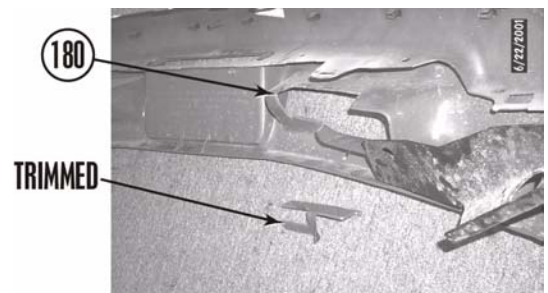

- c. Install front bumper (14) on four *kit* 2" x 2" spacer blocks (144) and frame (19) with four *kit* 3/8" USS washers (168) and *kit* 10mm x 80mm bolts (146). Do not tighten.

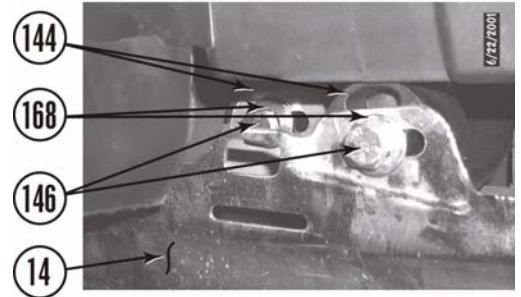

- d. Position two *kit* side front bumper brackets (181) and front bumper side brackets (17) on frame (19) and install four bolts (20). Mark two front bumper side brackets (17) from front as shown.

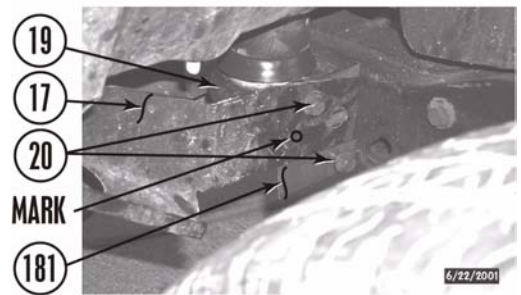

- e. Remove six bolts (20), two front bumper side brackets (17), and two *kit* side brackets (181) from frame (19). Drill two bumper side brackets (17) where marked using 13/32" drill bit.



- f. Install two *kit* front bumper side brackets (181) and front bumper side brackets (17) on bumper (14) and frame (19) with six bolts (20), two *kit* 7/16" x 1" bolts (182), four *kit* 7/16" USS washers (126), and two 7/16" nylock nuts (183). Do not tighten.

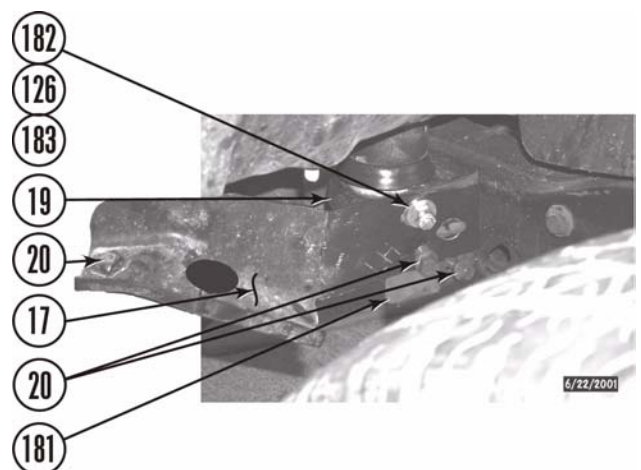

- g. Adjust front bumper (14) to fender (15) clearance using measurements from step B.2.a. Tighten nuts (183) and bolts (20, 145, 182) to 55 lb-ft.

19. Install the grille.

- a. Position grille for access and install two wire harness connectors (12) on running lights (13).
- b. Install two turn signal lamps (10) in turn signal housings (11).
- c. Install grille (8) on core support (9) with ten push clips (7).

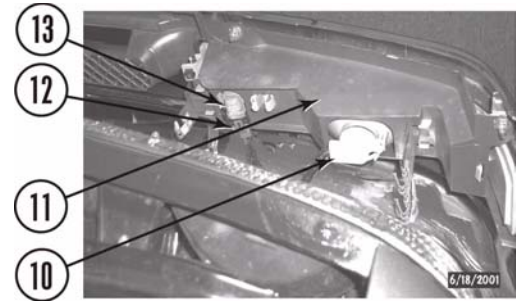

20. Install crush blocks.

NOTE
Short wheel base trucks have two plastic disks and use two *kit* crush blocks.

- a. Remove four plastic discs (184) from frame (19).
- b. Install four *kit* crush blocks (185) on frame (19) with four *kit* 5/16" USS washers (186) and four *kit* 5/16" self tapping bolts (187).

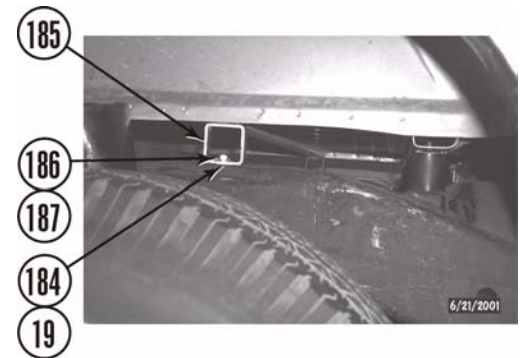

D. After installation is complete.

1. Install airbag fuse (5) in fuse panel (6). Install cover (4).

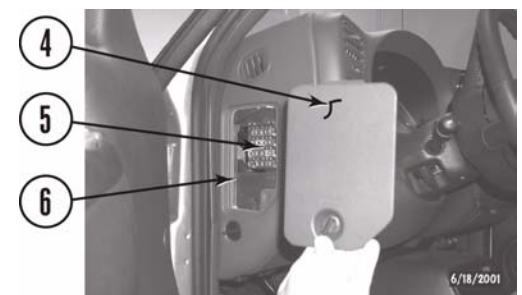

2. Connect both battery cables to the battery (3). Be sure to reconnect the positive cable (2) first, then the negative cable (1).

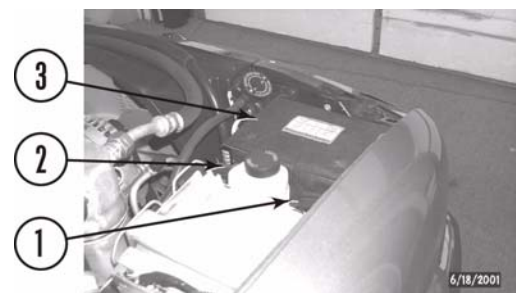

3. Install Gap Guards (you did remember to order your gap guards, didn't you?).
4. Stick *kit* warning sticker on the dash in plain sight of all vehicle occupants.
5. Double check the vehicle.

⚠CAUTION

Re torque all fasteners after 500 miles and after off road use. All body lift components should be visually inspected and fasteners re torqued during routine vehicle servicing.

- a. Check all mounting hardware to ensure it is properly tightened.
 - b. Check all wires, hoses, cables, etc. to ensure they have been properly connected and there is ample slack. With the number of hoses on this vehicle, it is vital that this be checked thoroughly.
 - c. Check vehicle electrical system.
6. Start vehicle and check the steering in both directions to ensure that there is no bind. If steering is binding (does not freely return steering wheel to center after a turn), binding can be corrected as follows:
 - a. Perform Steps A.5. and A.6. to remove battery cables and SIR fuse.
 - b. Remove ten screws (188) and under dash cover (189) from dash (190). Remove screw (188) and bulb (191) from under dash cover.
 - c. Remove parking brake cable (192) from shoe (193).

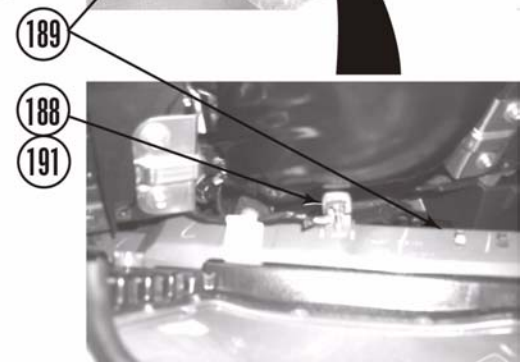
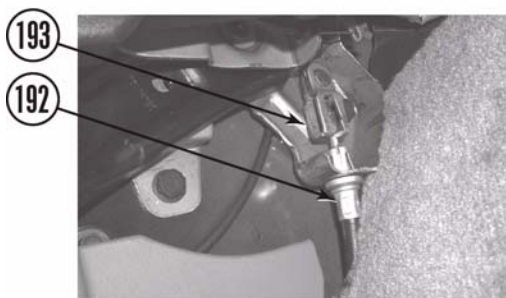
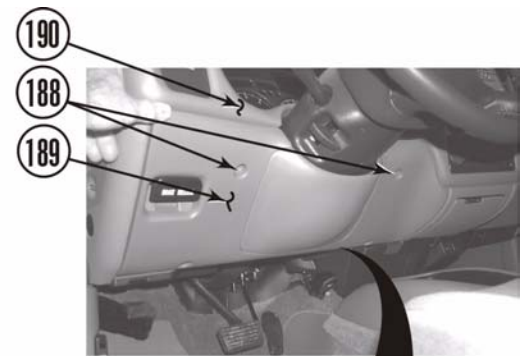

- d. Remove screw (188) (there may be two) and inner panel (194) from dash (190).

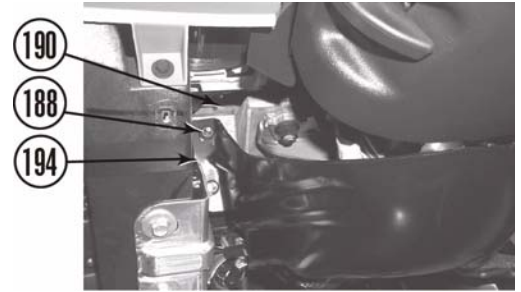

- e. Remove two screws (188), harness (195), and junction box (196).

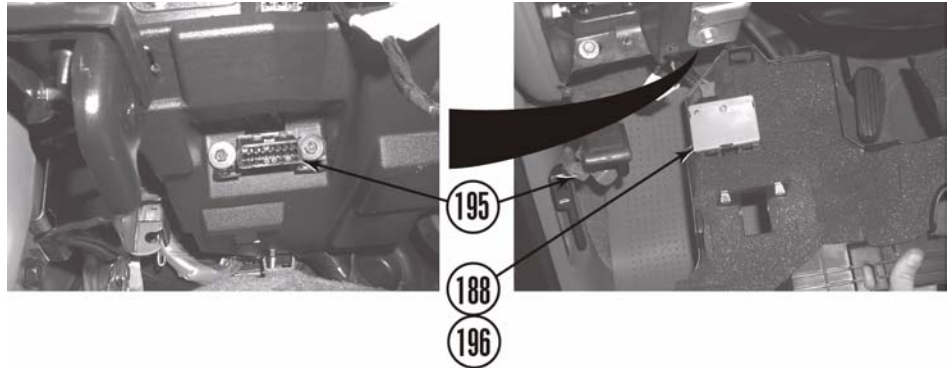

- f. Remove two nuts (197) from steering column collar (198) and let steering column drop to seat.

- g. File out two holes in steering column collar (198) as shown.

- h. Install steering column collar (198) with two nuts (197).

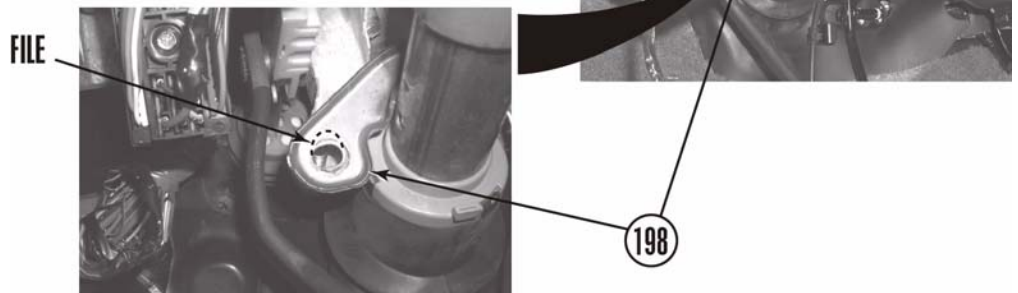

- i. Install junction box (196) and harness (195) with two screws (188).

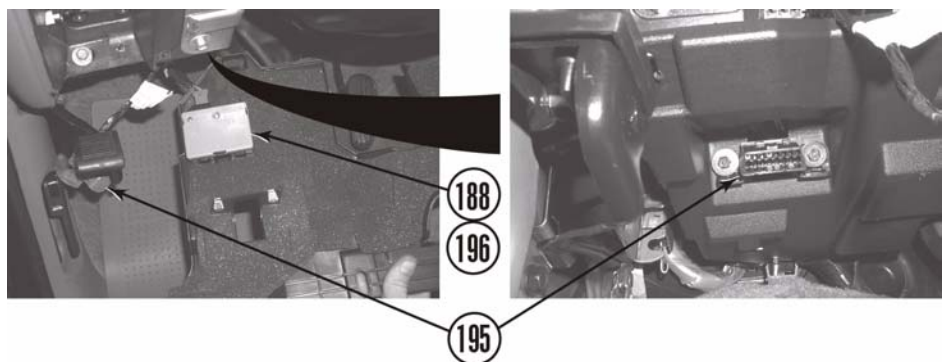

- j. Install inner panel (194) on dash (190) with screw (188).

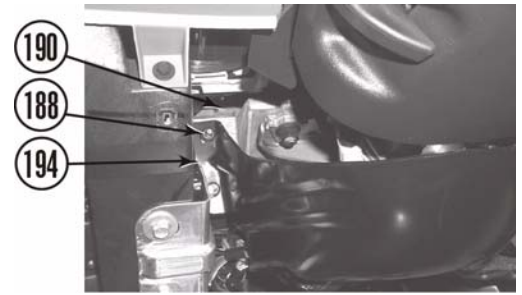

- k. Position parking brake cable (192) in shoe (193).

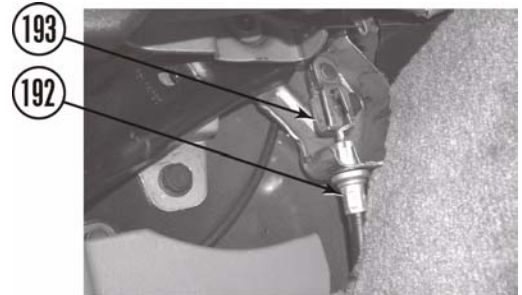

- l. Install bulb (191) with screw (188). Install under dash cover (189) on dash (190) with ten screws (188).

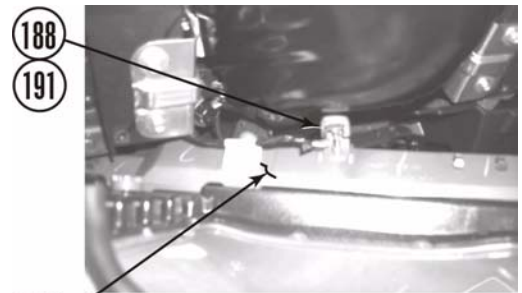

- m. Perform Steps F.1 and F.2. to install SIR fuse and battery cables.

- n. Start vehicle and check the steering in both directions to ensure that there is no bind.

- o. Check clutch operation. Check the operation of the brake system and the parking brake. Check both shift levers' operation. Ensure that there is proper engagement in all gears and 4 wheel drive ranges.

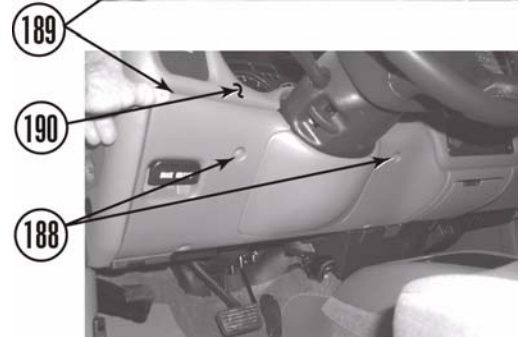

- p. Test drive vehicle in all gears and 4 wheel drive ranges. Pay close attention to all vehicle systems. Check all hardware again in 500 miles and as part of your regular maintenance schedule.

⚠CAUTION

Performance Accessories does not recommend any particular wheel and tire combinations for use with its body lifts and cannot assume responsibility for the customer's choice of wheels and tires. Reference your owner's manual for recommended tire sizes and warnings related to the use of oversized tires. Larger wheel and tire combinations increase stress and wear on steering and suspension components, which leads to increased maintenance and higher risk for component failure. Larger wheel and tire combinations also alter speedometer calibration, braking effectiveness, center of gravity, and handling characteristics. Consult with an experienced local off road shop to find what wheel and tire combinations work best with your vehicle.

⚠NOTE

All warranty information, instruction sheets, and other documents regarding the installation of this product must be retained by the vehicle owner. Information contained in the instructions and on the warranty card will be required for any warranty claims. The vehicle owner needs to understand the modifications made to his vehicle and how they affect vehicle handling and performance. Failure to provide the customer with this information can result in damage to the vehicle and severe personal injury.

Copyright 11/02 Performance Accessories. Reproduce this material in any way without written permission and be prosecuted to the fullest extent of the law.

E. Kit Parts List.

Quantity	Description
10	2" x 3" blocks
10	2" x 2" blocks
2	Rear bumper brackets
1	Lower fan shroud support
1	ZR-2 fuel filler extension 1"
1	Fuel filler extension 2"
1	Vent hose extension 11/16"
4	Crush blocks (2- short bed)
2	Side bumper brackets
1	Front oil filler bracket
1	Rear oil filler bracket
1	Warning to driver sticker
1	Logo sticker
1	6ml bottle Loctite
1	Bolt pack BP192
	Bolts
8	12mm x 140mm bolts
8	10mm x 80mm bolts
8	7/16" USS washers
8	3/8" USS washers
1	Hardware pack HP192
	Bolts
3	1/4" x 1" bolts
4	10mm x 80mm bolts
2	1/2" x 3" socket shoulder bolts
2	7/16" x 1" bolts
4	3/8" x 3 1/2" bolts
	Washers
6	1/4" SAE washers
4	1/2" USS washers
4	7/16" USS washers
14	3/8" USS washers
	Nuts
3	1/4" nylock nuts
4	14mm nylock nuts
2	7/16" nylock nuts
6	3/8" nylock nuts
	Miscellaneous
1	1" conduit clamp
1	3" ground strap
1	ground strap (z-shaped)
2	#36 hose clamps
2	#28 hose clamps
2	# 10 hose clamps
4	2" fan shroud spacer tubes
2	zip ties
1	#12 x 3/4" sheet metal screw
4	5/16" self tappers (2- short bed)
4	5/16" USS washers(2- short bed)