



3651 N Highway 89 • Chino Valley, AZ 86323
(928) 636-7080

CHEVY/GMC 1500 & 2500 TAHOE, SUBURBAN, YUKON & YUKON XL 3" BODY LIFT INSTALLATION INSTRUCTIONS 2000-2005 **KIT# 10113**

⚠ WARNING
Installation of a Performance Automotive Group body lift kit will change the vehicle's center of gravity and handling characteristics both on- and off-road. You must drive the vehicle safely! Extreme care must be taken to prevent vehicle rollover or loss of control, which could result in serious injury or death. Avoid sudden sharp turns or abrupt maneuvers and always make sure all vehicle occupants have their seat belts fastened.

⚠ WARNING
Before you install this kit, read and understand all instructions, warnings, cautions, and notes in this instruction sheet and in the vehicle owner's manual.

⚠ CAUTION
Proper installation of this kit requires knowledge of the factory recommended procedures for removal and installation of original equipment components. We recommend that the factory shop manual and any special tools needed to service your vehicle be on hand during the installation. Installation of this kit without proper knowledge of the factory recommended procedures may affect the performance of these components and the safety of the vehicle. We strongly recommend that a certified mechanic familiar with the installation of similar components install this kit.

⚠ WARNING
This kit should only be installed on a vehicle that is in good working condition. Before you install the kit, thoroughly inspect the vehicle for corrosion or deformation of the sheet metal around the factory body mounts. If the vehicle is suspected to have been in a collision or misused, do not install this kit. Off-road use of your vehicle with this kit installed may increase the stress applied to the factory body mounts. We do not recommend that any vehicle with a body lift kit be involved in any extreme off-road maneuvers such as jumping. Failure to observe this warning may result in serious personal injury and/or severe damage to your vehicle.

⚠ WARNING
Many states and municipalities have laws restricting bumper heights and vehicle lifts. Consult state and local laws to determine if the changes you intend to make to the vehicle comply with the law.

⚠ WARNING
The installation of larger tires may reduce the effectiveness of the braking system.

⚠ WARNING
Always wear eye protection when operating power tools.

⚠ WARNING
Before you install this kit, block the vehicle tires to prevent the vehicle from rolling.

⚠ WARNING
Accidental deployment of the air bag can result in serious personal injury or death. To avoid accidental deployment during installation of the kit, the Supplemental Restraint System (SRS, or airbag) must remain deactivated. Do not allow anyone near the airbag during installation. Refer to the factory service manual or owner's manual for the recommended procedure to disable the SRS. After you install the kit, reactivate the SRS before driving the vehicle.

⚠ NOTE
Performance Automotive Group recommends using the Loctite® supplied in the kit on the threads of all kit nuts and bolts unless specified otherwise in these instructions.

Before Starting Installation

NOTE
Kit parts are prefaced by the word kit and appear in bold print.

- Carefully read all warnings and instructions completely before beginning.
- Verify all parts have been received in this kit by checking the parts list at the end of this document.

NOTE
If parts are missing from kit, please be prepared to provide the following information:

- Name** of purchase location
- Bar Code** on side of box
- Date** above bar code
- Date** inside box cover
- Inspector #** from inside box cover

- Only install this kit on the vehicle for which it is specified.** If anytime during the installation you encounter something different from what is outlined in the instructions, call technical support at (928) 636-7080.

- Special tools needed:
 - Die grinder or similar tool capable of cutting metal and plastic.
- Park vehicle on a clean, dry, flat, level surface and block tires so vehicle cannot roll in either direction.

Engine Compartment

- Disconnect both battery cables. Disconnect negative cable first, then positive cable.

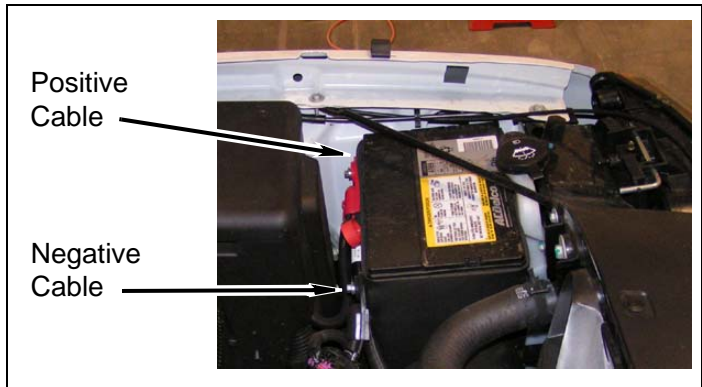

- Airbag Fuse

NOTE
The location of the airbag fuse may vary; check the owner's manual.

- Remove fuse cover.
- Remove airbag fuse.

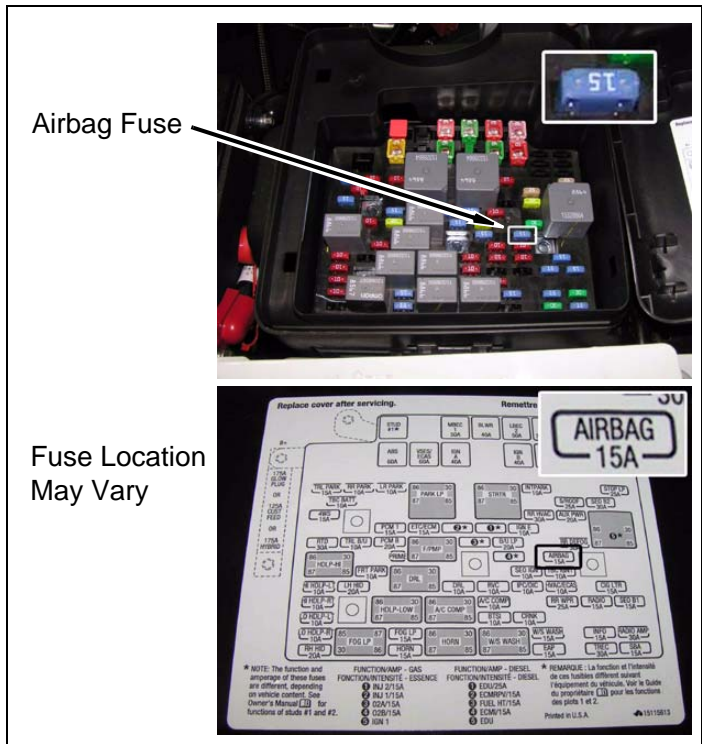

Prepare to Install Kit

Measurements

1. Measure and record distance between front bumper and fenders.

Driver Side _____ Passenger Side _____

2. Measure and record distance between rear bumper and cab.

Driver Side _____ Passenger Side _____

Front of Vehicle

1. Grill

- a. Remove seven panel clips and cover from core support.

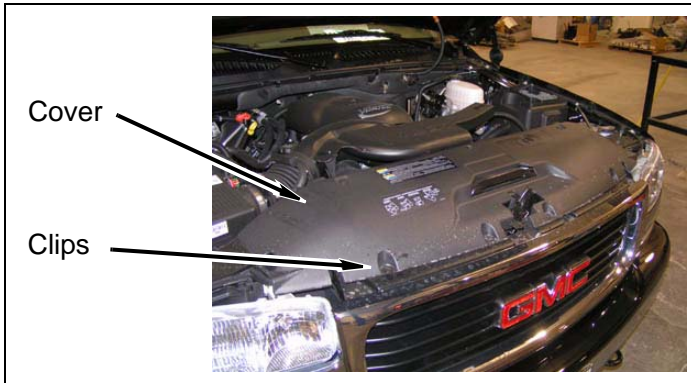

- b. Remove bolt, two D-zus fasteners, two clips and grill from core support and front fenders.

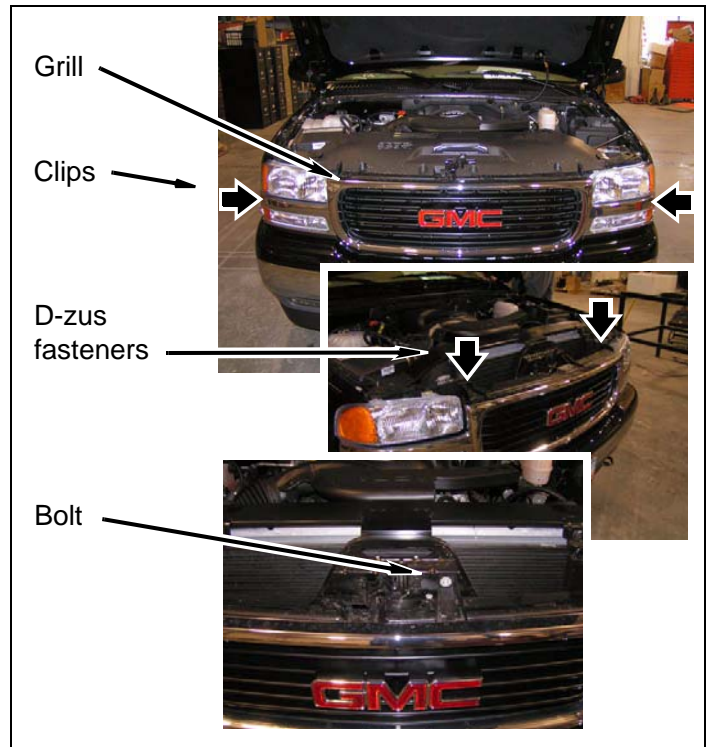

2. Front bumper

- a. Remove two wire connectors from fog lamps, if equipped.

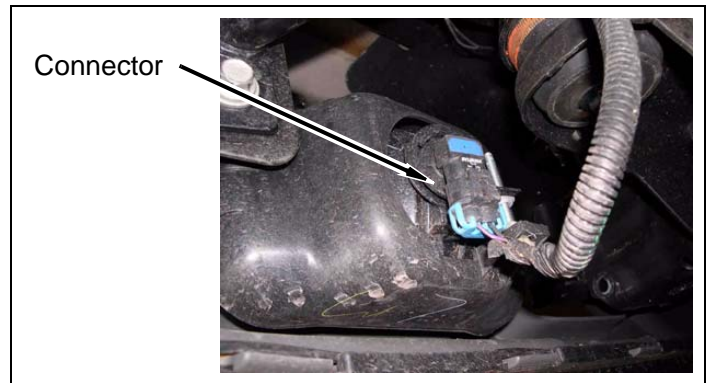

b. Remove ten bolts, bumper and bumper support brackets from frame.

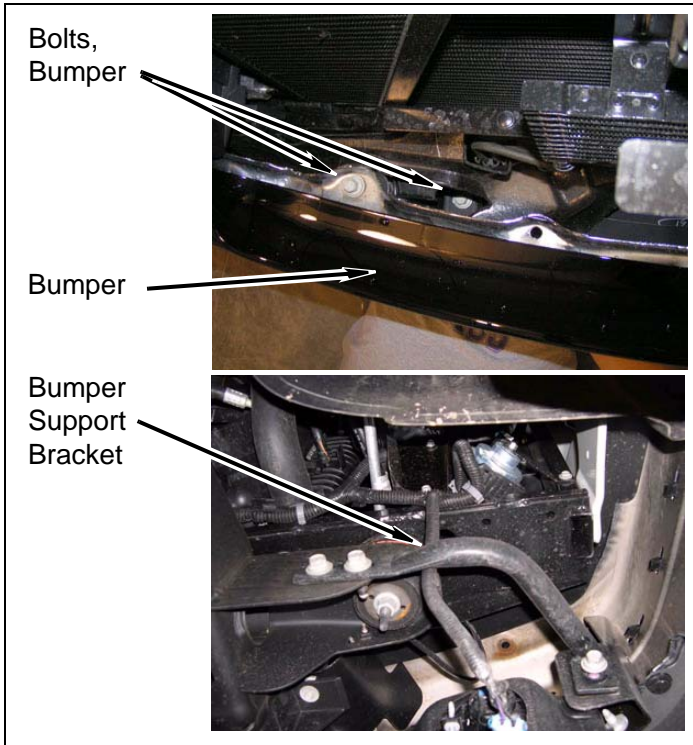

5. Remove bolts and lower guard from core support and frame.

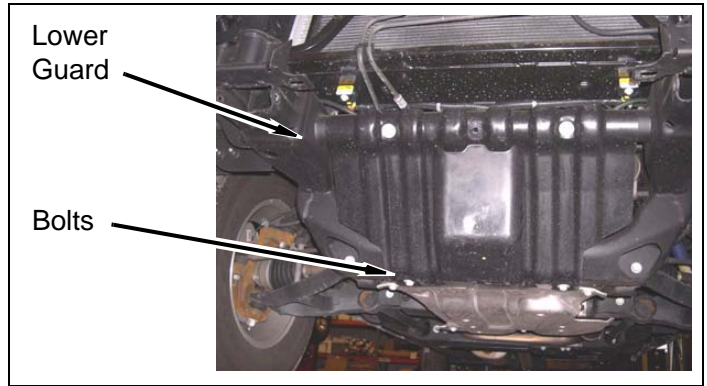

6. Remove clips and air flap from core support. Remove any wire harnesses from air flap.

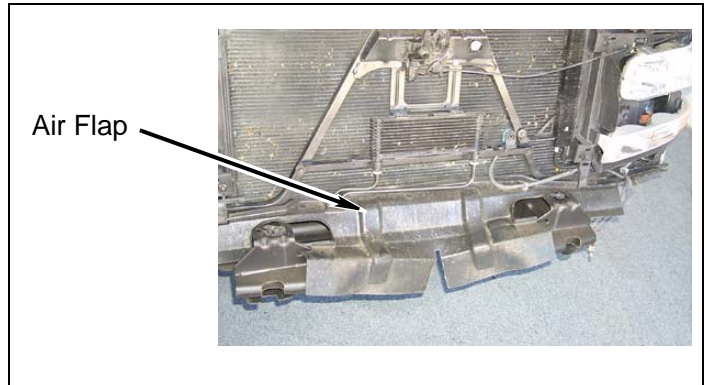

3. Remove bolts and tow hooks from frame rails.

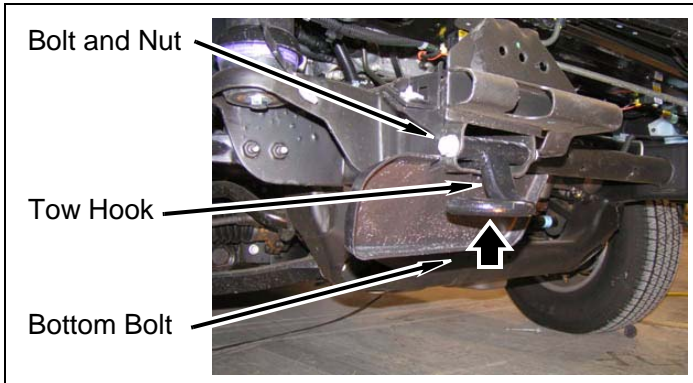

7. Transmission cooler

a. Remove two bolts, two panel clips and transmission cooler from core support and allow cooler to settle on frame.

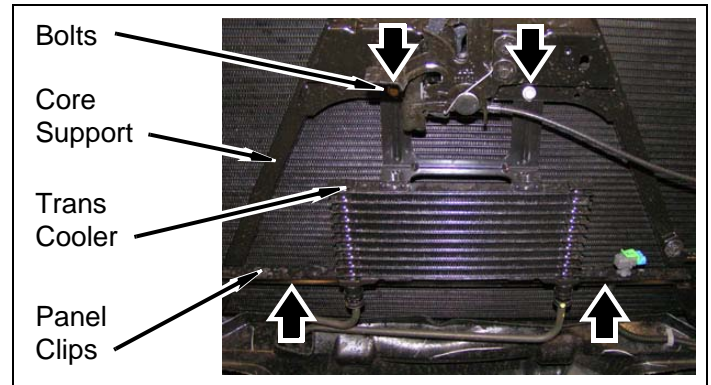

4. Remove bolts and tow hook covers from frame rails.

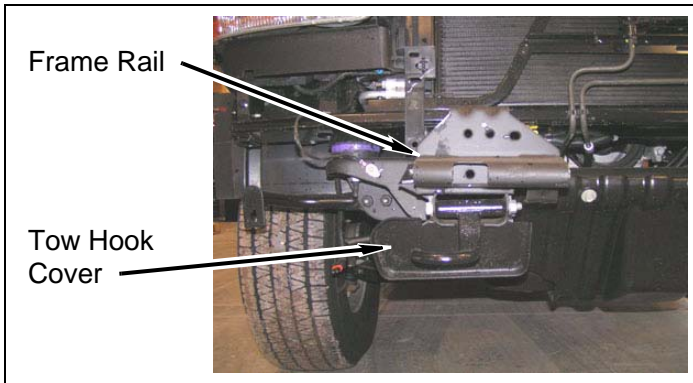

b. Remove cooler lines from core support clip.

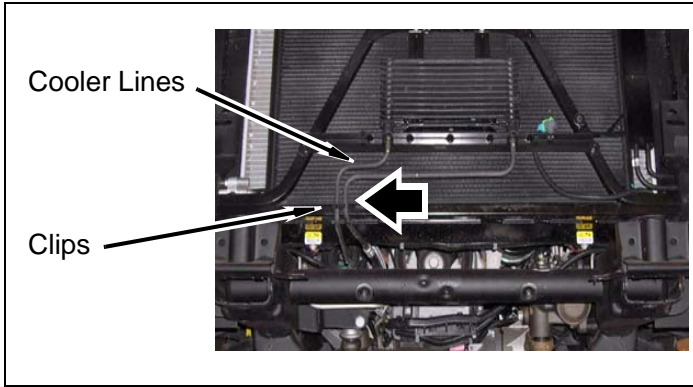

c. Remove bolt and ground strap from front cab mount on passenger side.

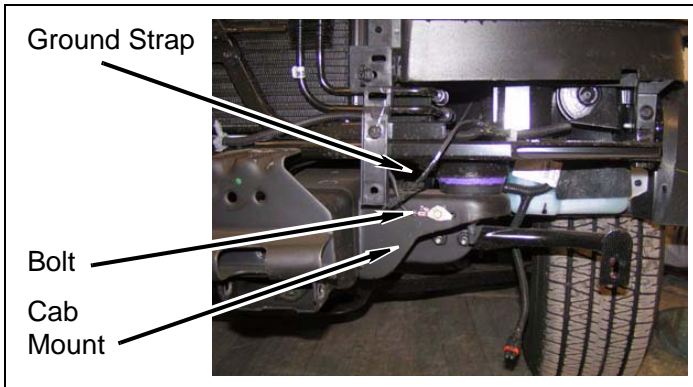

d. Repeat above step for driver side.

a. Remove bolt and engine cover from top of engine.

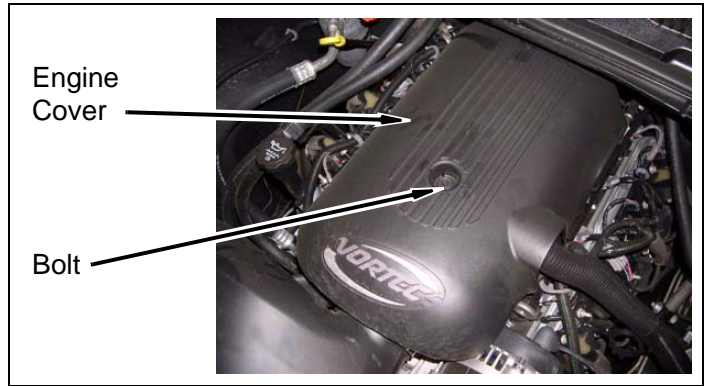

b. Loosen throttle body and air box hose clamps.

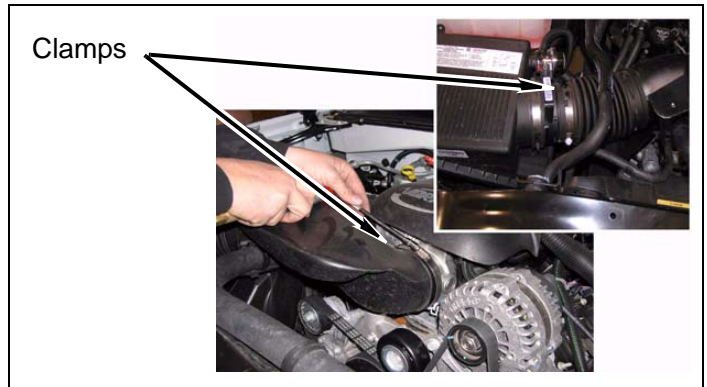

c. Remove overflow and radiator hoses from two-clips.

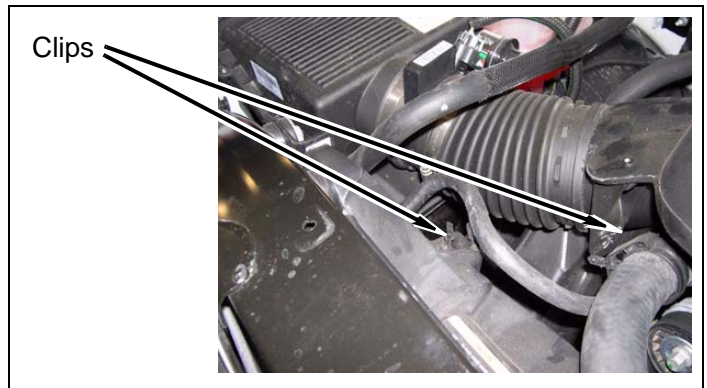

3. **Electric & Mechanical fan:** Remove clip and radiator hose from radiator.

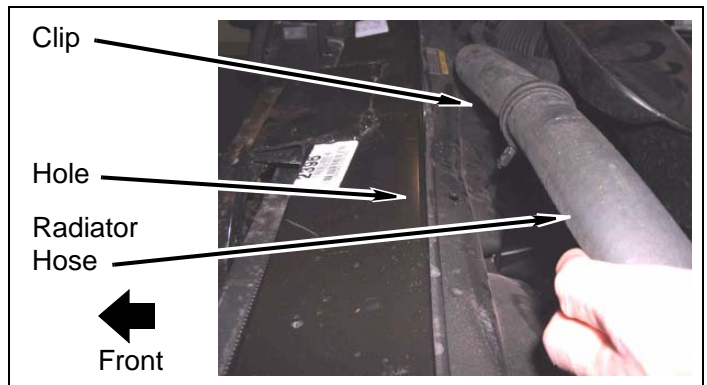

Engine Compartment

1. Remove nut and ground strap from firewall.

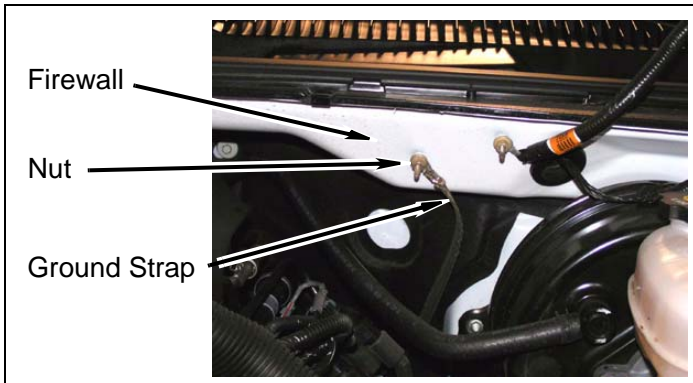

2. Engine

4. **Mechanical fan: Radiator**

- a. Remove two bolts and four pop-ups from fan shroud and core support.

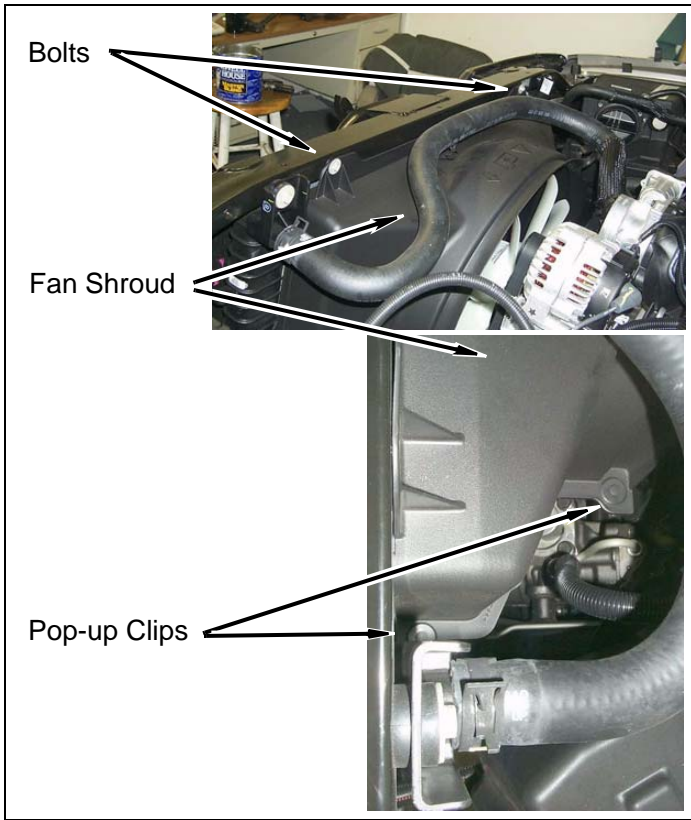

- b. Remove top fan shroud from bottom fan shroud, radiator and vehicle. Rotate bottom fan shroud around fan and remove from vehicle.

- c. Remove four bolts from fan and fan clutch. Rest fan on fan clutch shaft.

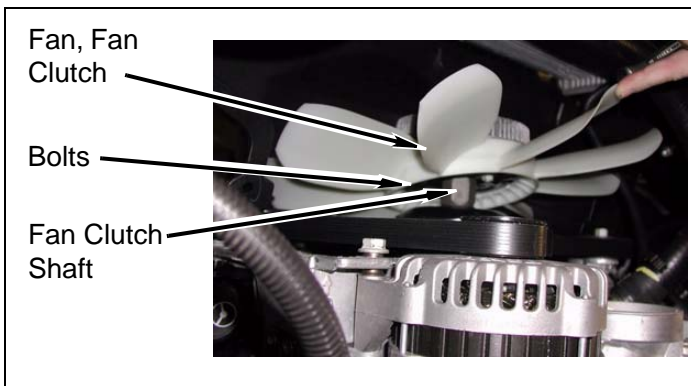

- 5. Remove heater hoses from clip on passenger side.

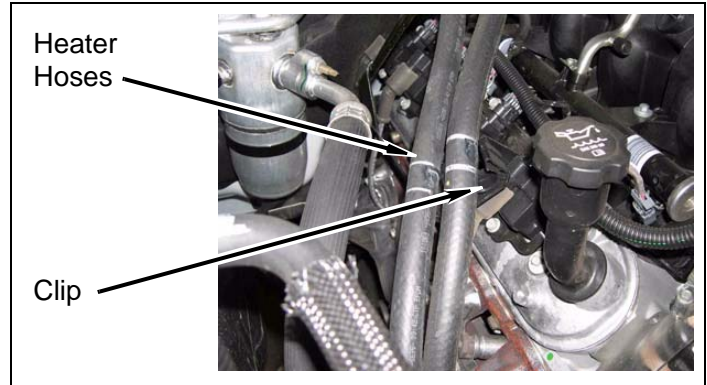

- 6. Remove wire harness from wire clip on driver side.

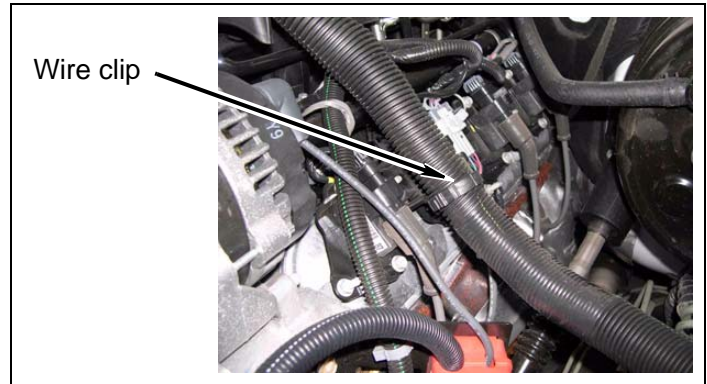

- 7. Carefully pull brake lines from frame rail clips.

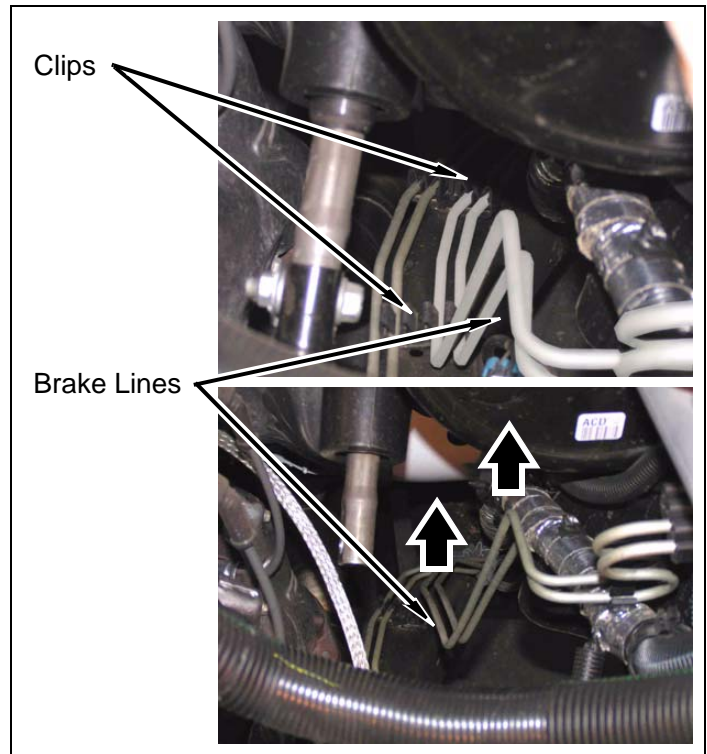

8. Remove wire harness from three clips near brake lines on driver side.

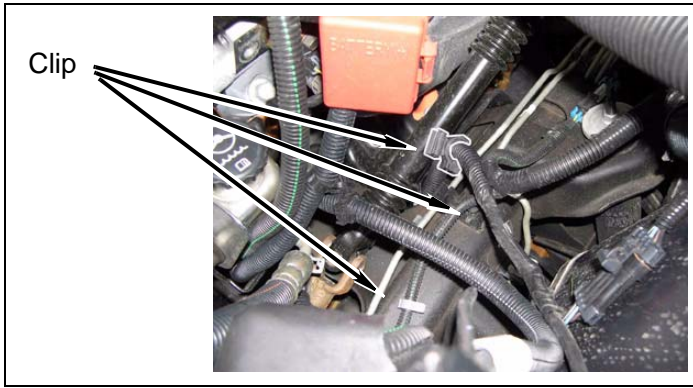

- b. Mark upper shaft in relation to lower shaft as shown.

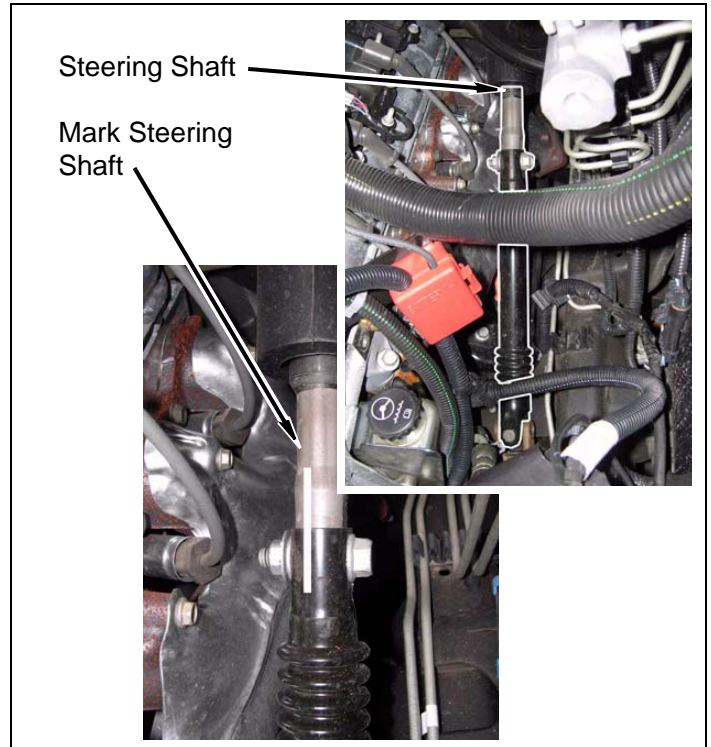

9. Steering shaft

⚠ WARNING

Accidental deployment of the air bag can result in serious personal injury or death. To avoid accidental deployment during installation of the lift kit, the Supplemental Restraint System (SRS, or airbag) must remain deactivated. Do not allow anyone near the airbag during installation. Refer to the factory service manual or owner's manual for the recommended procedure to disable the SRS. After kit installation, the SRS must be reactivated before driving the vehicle.

⚠ CAUTION

If the following step is not performed, the airbag clock-spring could be damaged. Do not turn the steering wheel while the steering shaft is disconnected.

- a. Strap steering wheel to prevent accidental movement.

- c. Remove bolt, nut and upper steering shaft from lower steering shaft.

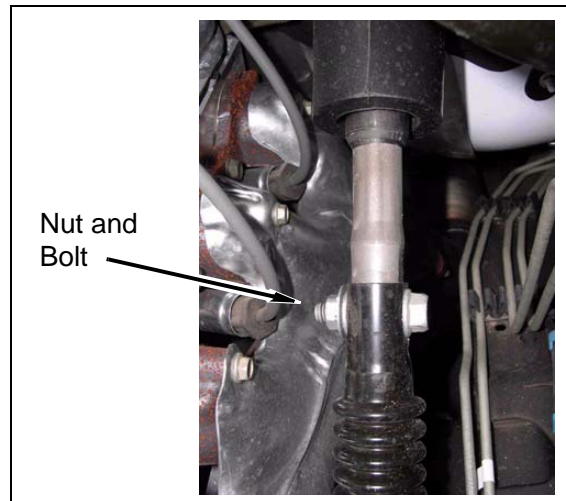

Underside of Vehicle

1. Wire harnesses

- a. Remove wire harness from harness clip on driver side frame rail.

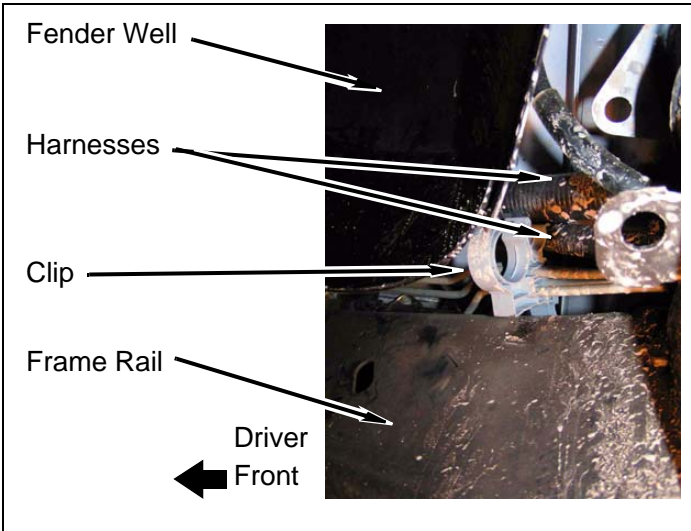

- b. Remove harness clips from frame rail. Remove bolts and ground straps from frame.

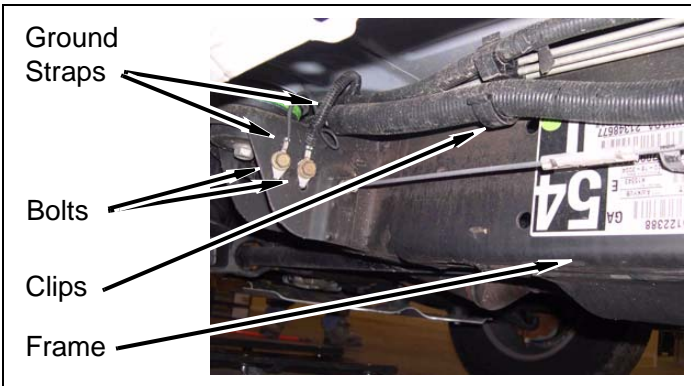

- c. Remove wire clips from body and frame rail along passenger side.

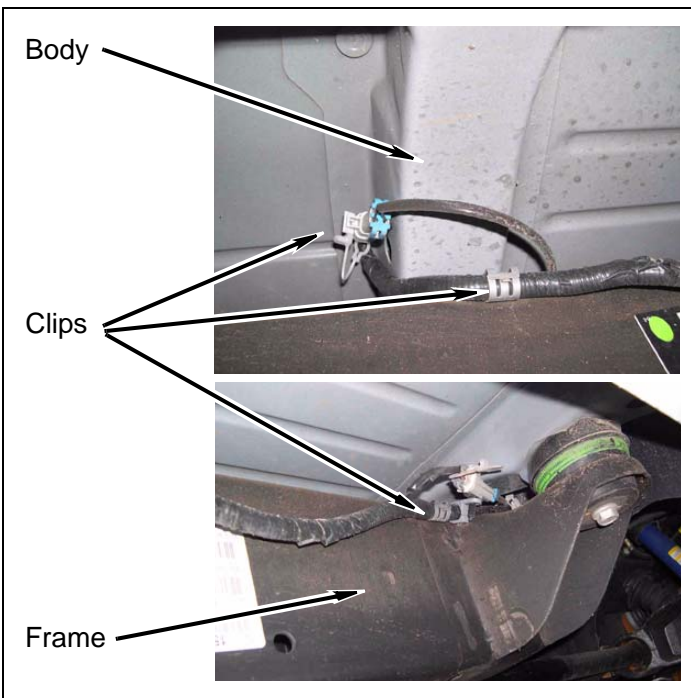

2. Without adjuster: Parking brake cable

- a. Pull slack into parking brake cable. If necessary, attach locking pliers to parking brake cable to maintain slack.
- b. Disconnect front parking brake cable from junction.

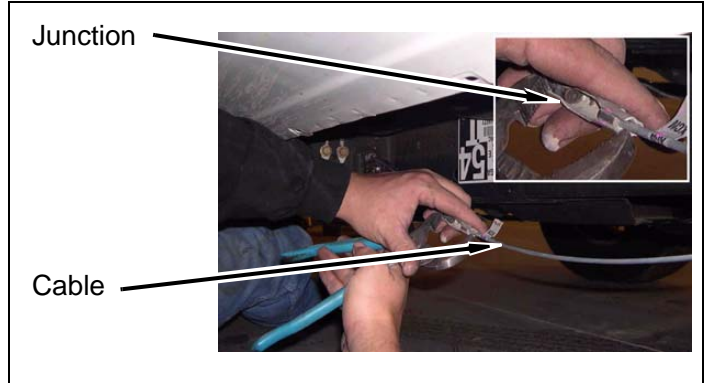

3. With adjuster: Parking brake cable

- a. Measure length of threads on parking brake cable adjuster. Remove nut from cable adjuster and clevis.

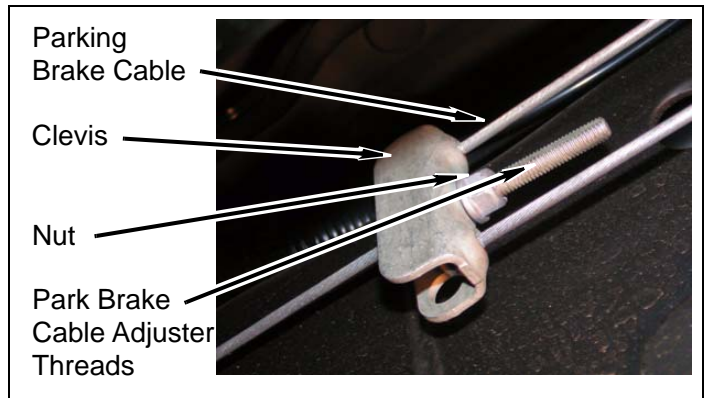

- b. Pull parking brake cable through two frame mounting pads.

Rear of Vehicle

1. Fuel filler

⚠ WARNING

Use extreme caution when working near fuel line(s) and fuel tank(s). Clean up spilled fuel immediately. Any spark could cause an explosion or fire resulting in serious personal injury and/or property damage.

- a. Remove fuel filler cap.

b. Remove three bolts and fuel filler from bed.

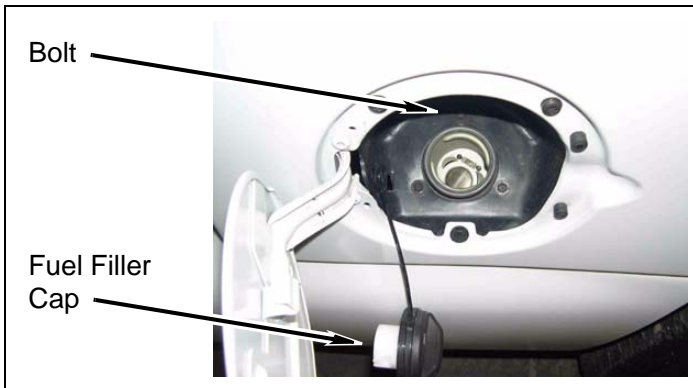

c. **2005 model:** Remove bolt and fuel filler from frame.

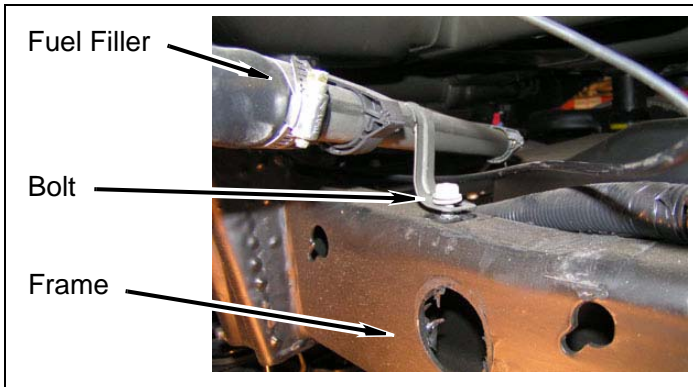

c. **2000-2004 models:** Remove three wire harnesses and clips from rear bumper.

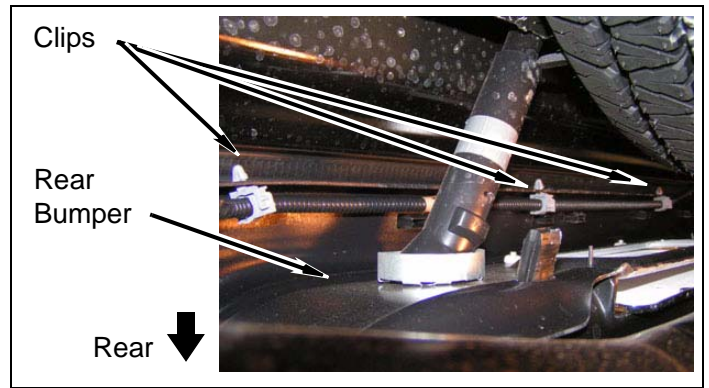

d. **2005 model:** Remove bumper wire harness connector from passenger side body.

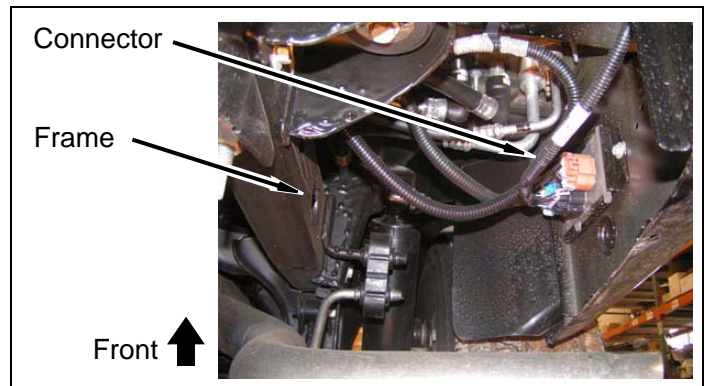

e. Remove six bolts from two rear bumper brackets and frame.

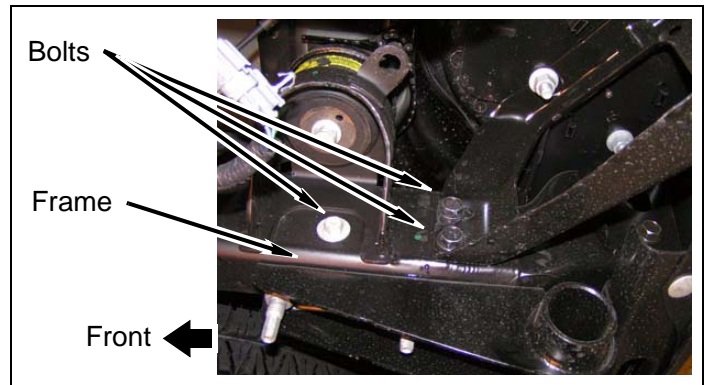

2. Rear bumper

a. Remove spare tire (refer to Owner's Manual).

b. **2000-2004 models:** Disconnect two license plate lights from rear bumper.

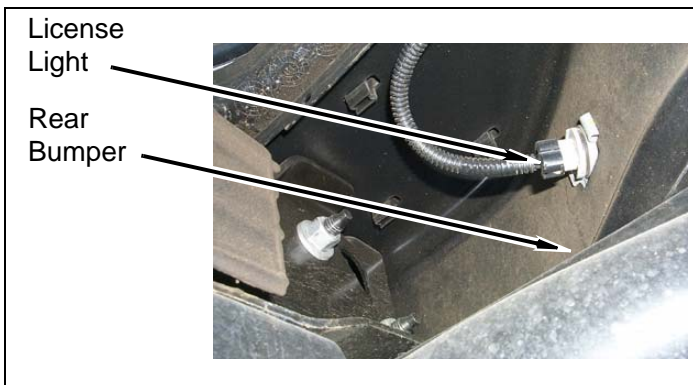

- f. If equipped with a trailer hitch, remove four bolts from hitch, rear bumper and frame.

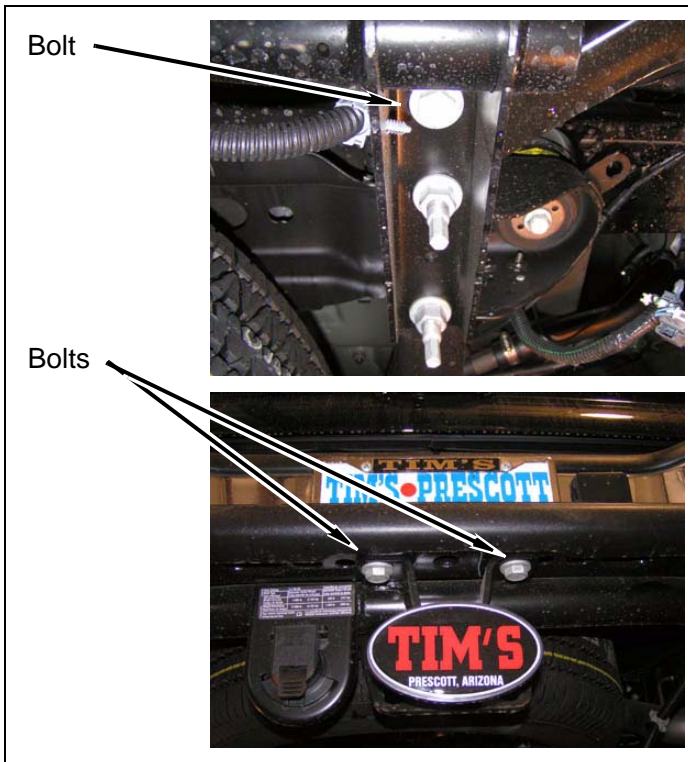

- g. Remove two rear bumper brackets and rear bumper from frame.
- h. Remove four nuts, bolts and two rear bumper brackets from rear bumper.

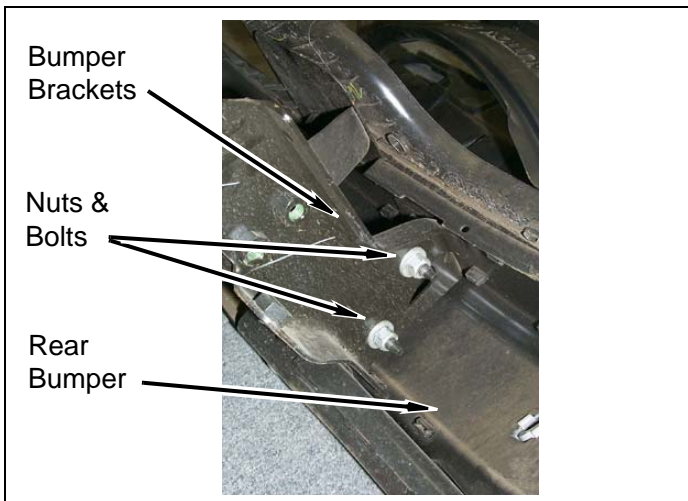

Install Kit

Cab

1. Lift cab
 - a. Loosen, but DO NOT REMOVE, cab mounting bolts on driver side.

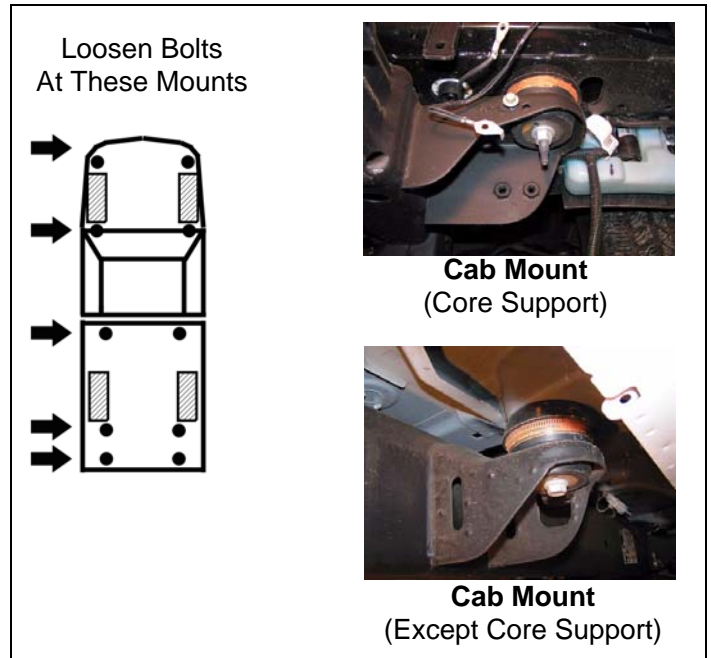

NOTE:
The number of cab mounting bolts may vary with the length of the cab.

- b. Remove bolt and lower bushing from each cab mount on passenger side. Retain factory nut from front core support cab mount.

⚠ WARNING
 The *kit blocks* must be installed in addition to the factory upper and lower bushings. Installing the *kit blocks* without the factory upper and lower bushings could result in damage to the vehicle or serious personal injury.

- b. Install *kit blocks* on metal cups and upper bushings on each cab mount. DO NOT INSTALL lower bushings at this time.

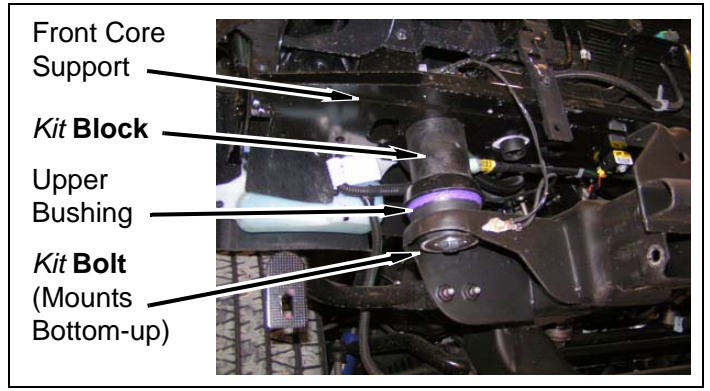
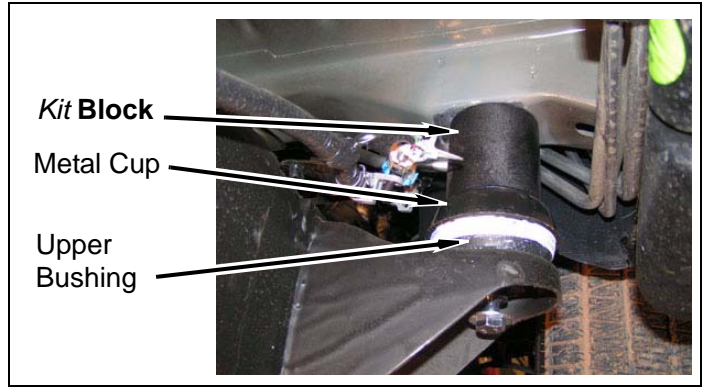

- c. Lower cab onto *kit blocks*.

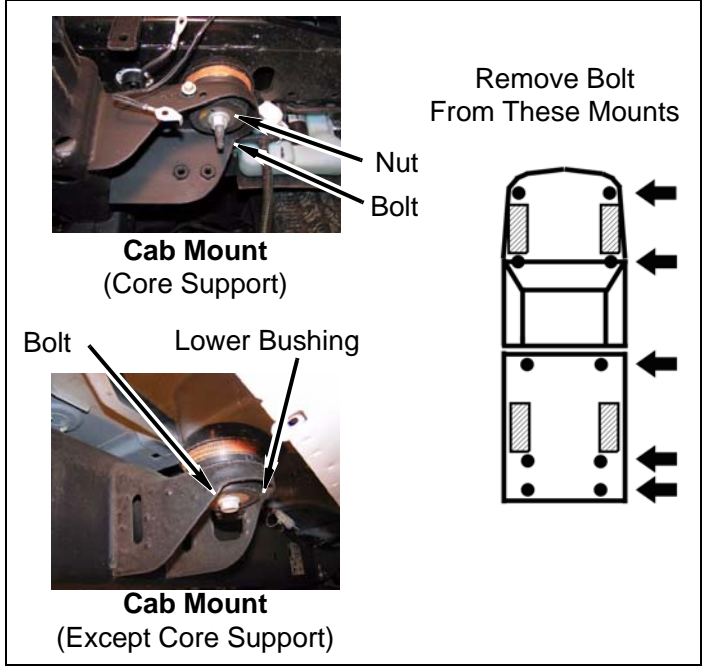

NOTE:
 Bolts in front two cab mounts are mounted down and through core support.

⚠ WARNING
 Use extreme caution when lifting body from frame. To prevent serious personal injury, ensure the lifting device is securely placed. Keep your hands out from between the body and frame.

⚠ CAUTION
 Continually check hoses, wires, lines, etc. to be sure that everything is flexing properly and not binding, or damage to the vehicle could result. Be especially careful of the a/c hoses at the fire wall, the belt pulley, and at the core support. Ensure brake lines stretch while lifting. Bending the lines to gain ample slack may be necessary. Be extremely careful not to kink the lines.

2. Cab passenger side

- a. Position a hydraulic jack and a wood block under passenger side of cab (under the body seam). Slowly lift cab just enough to install a *kit block* on top of factory upper bushing.

- d. Install lower bushing, **kit bolt** (12mm-1.75 x 180mm) and **kit washer** (7/16" USS) on each cab mount, except front core support mount. DO NOT TIGHTEN.

- b. Remove each **kit bolt**, one at a time, and apply a few drops of **kit Loctite®** to threads. Install **kit bolt**, **kit washer** (7/16" USS), and lower bushing. TIGHTEN **kit bolt** to 55 ft. lbs.

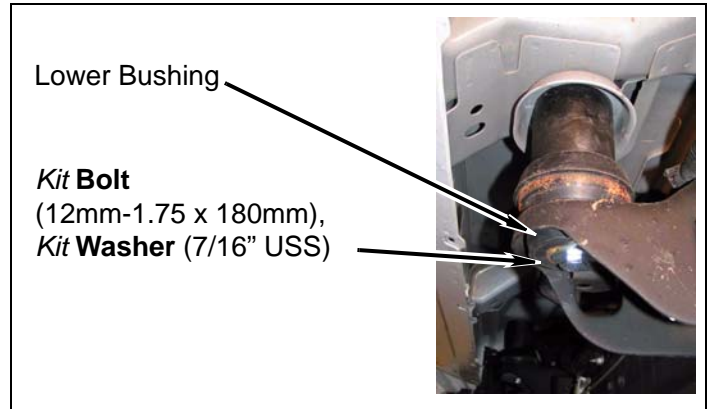
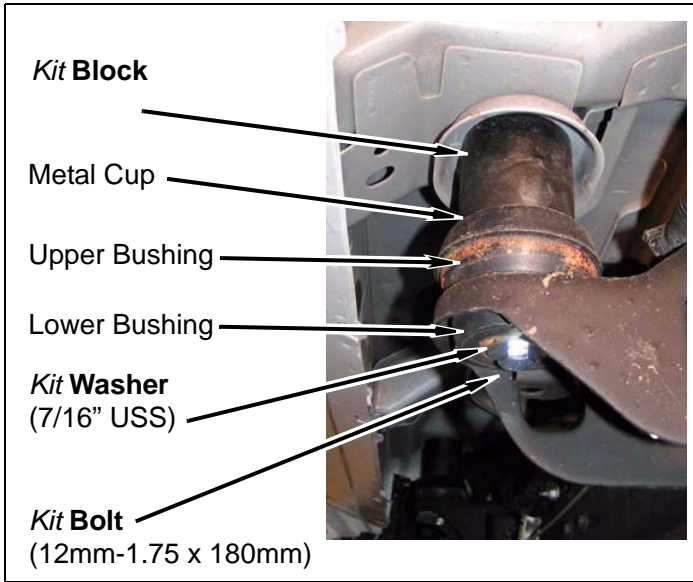

Rear of Vehicle

- 1. Rear bumper

- e. Install lower bushing, **kit bolt** (12mm-1.75 x 180mm) and **kit washer** (7/16" USS) on front core support cab mount. Use factory front core support cab mount nut. DO NOT TIGHTEN.

⚠ WARNING

The following procedure is intended only to enhance the appearance of the vehicle. The rear bumper will no longer be rated for towing of any kind. Towing with the rear bumper after it has been lifted can result in death, serious personal injury, or damage to the vehicle. Towing after the bumper has been lifted should be accomplished using a rated Class III receiver type hitch.

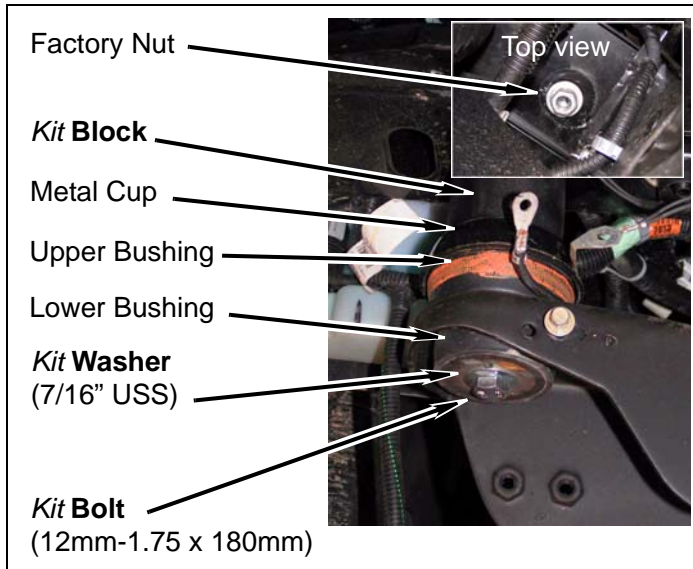

- a. Trim frame for spare tire winch tube as shown.

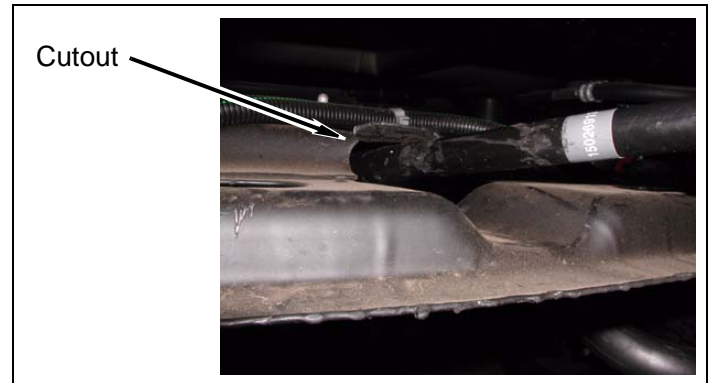

3. Cab driver side

- a. Repeat previous steps on driver side of cab.

- b. Install **kit bracket** (rear bumper, passenger) to rear bumper with factory hardware, two **kit bolts** (7/16" x 1-1/2"), four **kit washers** (7/16" USS) and two **kit nuts** (7/16" Nylock). DO NOT TIGHTEN.

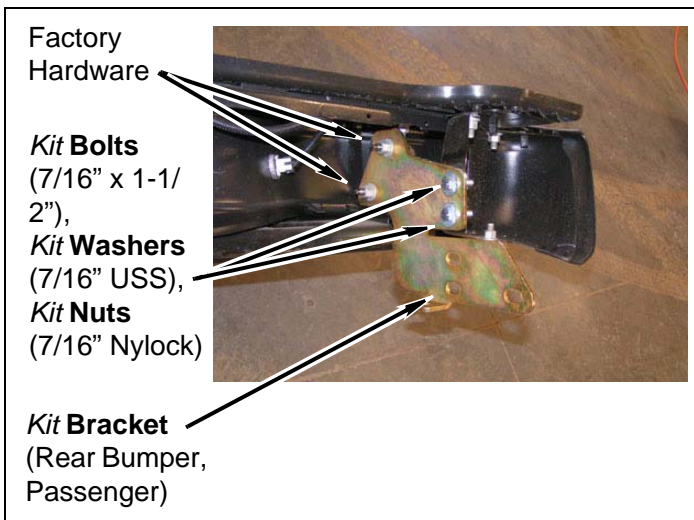

- c. Repeat above procedure for **kit bracket** (rear bumper, driver).

- d. Install rear bumper onto frame with four **kit bolts** (7/16" x 1-1/2"), eight **kit washers** (7/16" USS), four **kit nuts** (7/16" Nylock), two **kit bolts** (3/8" x 1-1/2"), four **kit washers** (3/8" USS) and two **kit nuts** (3/8" Nylock). DO NOT TIGHTEN. Ensure spare tire winch tube aligns with hole in bumper.

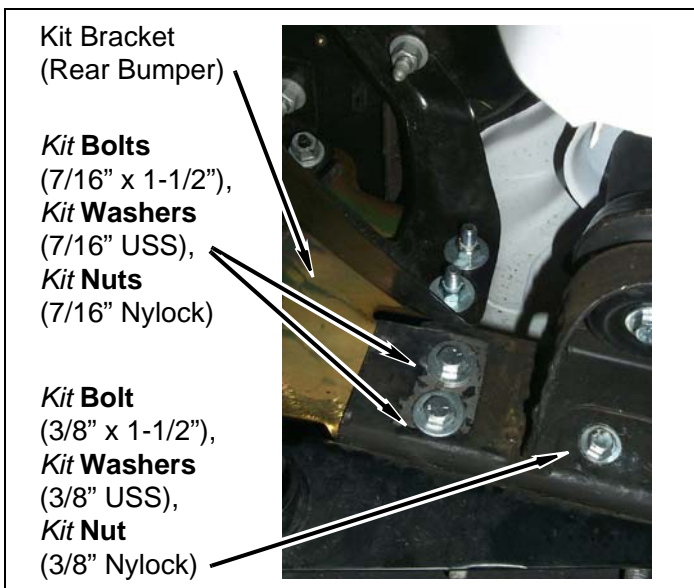

- e. Install rear bumper to trailer hitch (if equipped) with two factory bolts, two **kit washers** (square) and two **kit nuts** (14mm Nylock). DO NOT TIGHTEN.

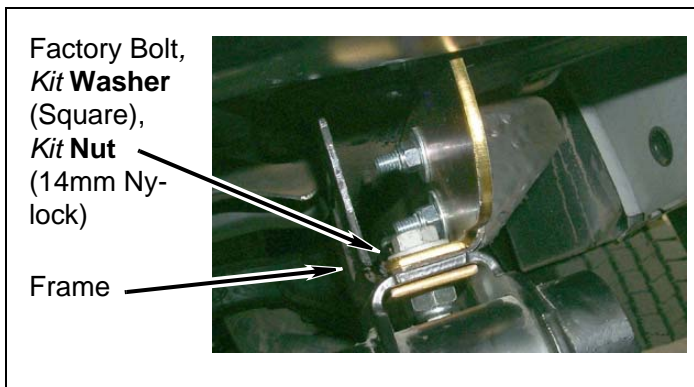

- f. Install **kit bracket** (trailer hitch) to rear bumper and trailer hitch (if equipped) with two **kit bolts** (14mm x 110mm) and two **kit washers** (14mm). DO NOT TIGHTEN.

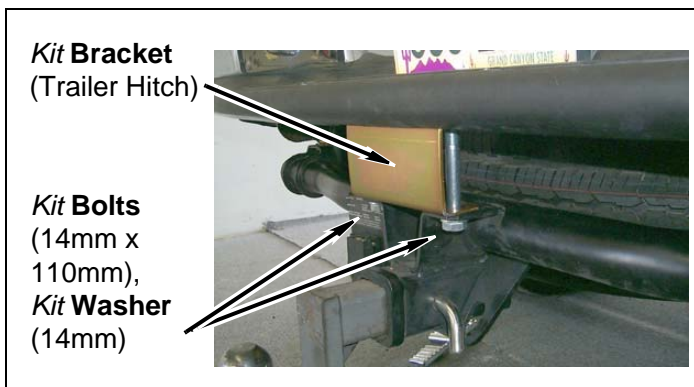

- g. Align rear bumper to previous cab-to-bumper measurements. Tighten all hardware.

- h. **2000-2004 models:** Install two license plate lights to rear bumper.

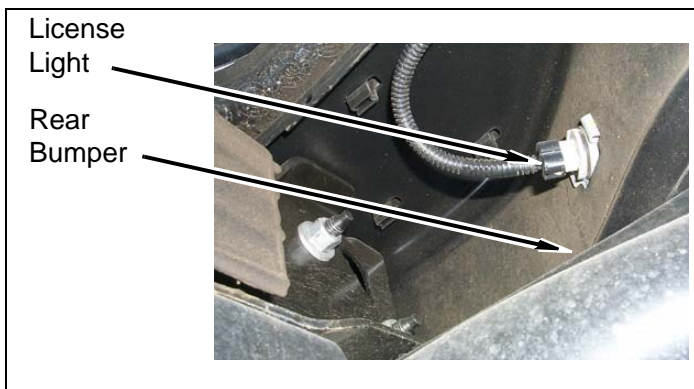

- i. **2000-2004 models:** Install three wire harnesses and clips to rear bumper.

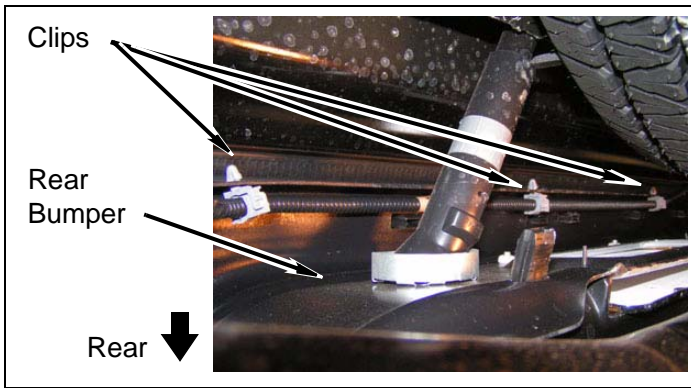

- j. **2005 model:** Install bumper wire harness connector to passenger side body.

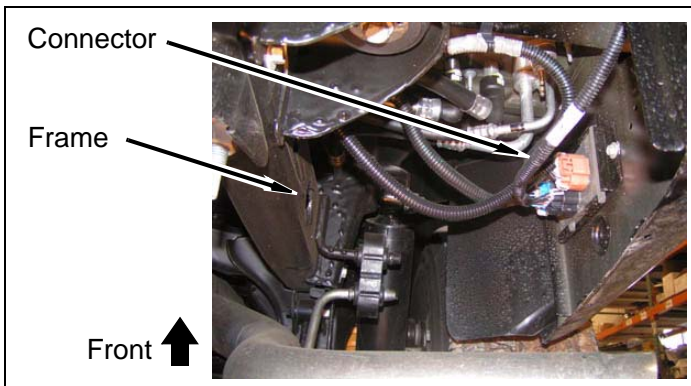

- k. Install spare tire (refer to Owner's Manual).

2. **2000-2004 models:** Fuel filler

⚠ WARNING
 Use extreme caution when working near the fuel lines and the fuel tank. Clean up spilled fuel immediately. A spark could cause an explosion or fire resulting in serious personal injury and property damage.

- a. Install fuel filler to body with three factory bolts.

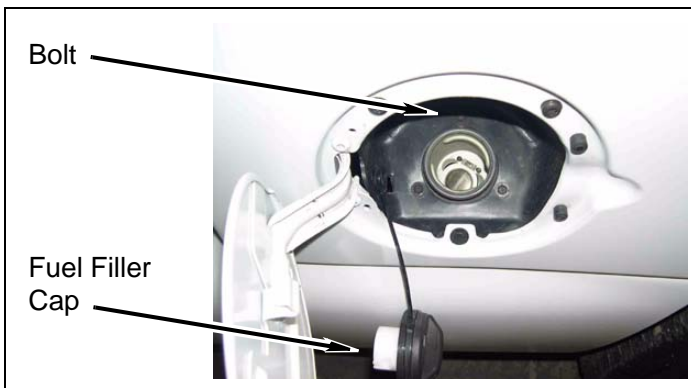

3. **2005 model:** Fuel filler

- a. Install fuel filler to frame with **kit spacer** (2" tube), **kit bolt** (8mm x 70mm) and **kit washer** (8mm).

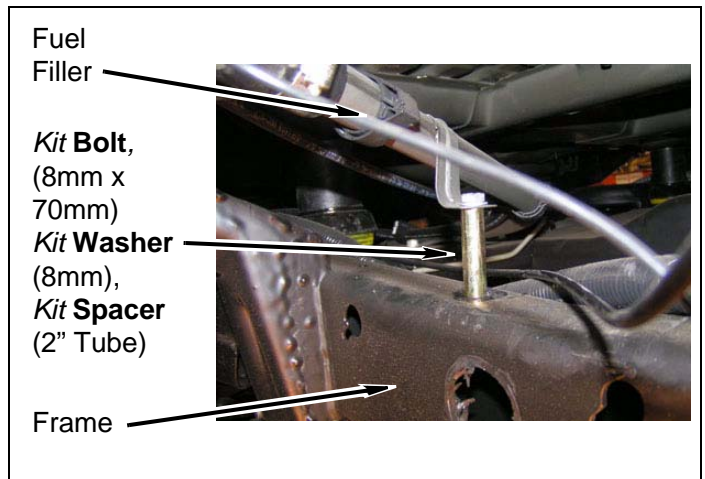

- b. Install fuel filler to body with three factory bolts.

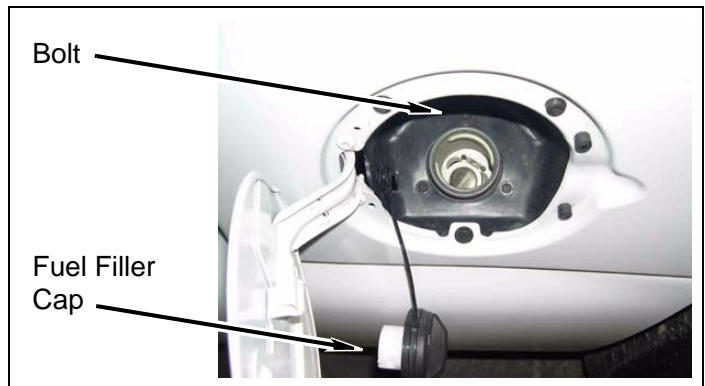

Underside of Vehicle

1. Parking brake cable

- a. Using **kit bracket** (parking brake) as a template, drill two 5/16" holes on frame driver side mounting pad as shown.

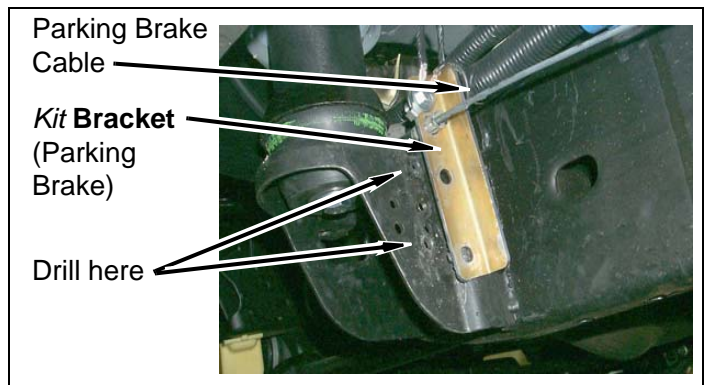

- b. Route parking brake cable through largest hole in **kit bracket** (parking brake).
- c. Install **kit bracket** (parking brake) to mounting pad using two **kit bolts** (5/16" x 1"), four **kit washers** (5/16" USS) and two **kit nuts** (5/16" Nylock).

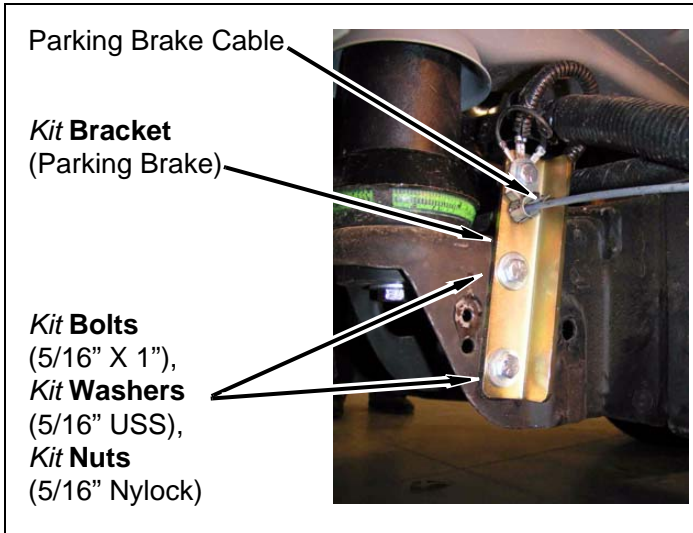

- d. Install two ground wires on **kit bracket** (parking brake) with **kit bolt** (5/16" x 1"), two **kit washers** (5/16" USS) and **kit nut** (5/16" Nylock).

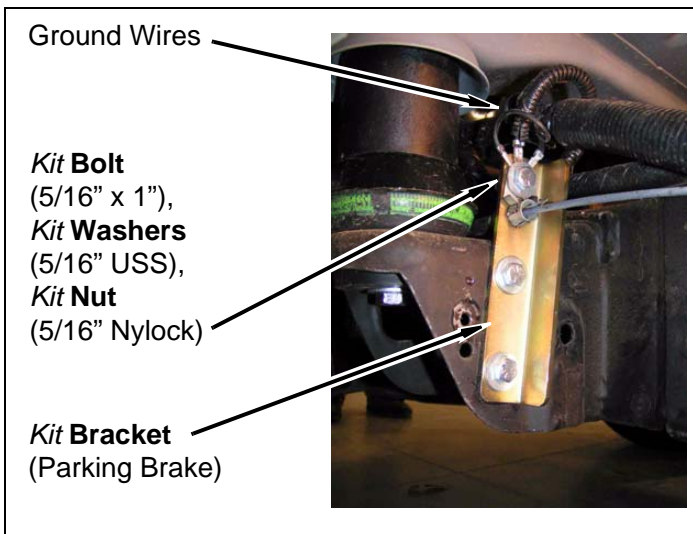

2. Wire harnesses

- a. Install wiring harness into clips on frame rail, if possible.

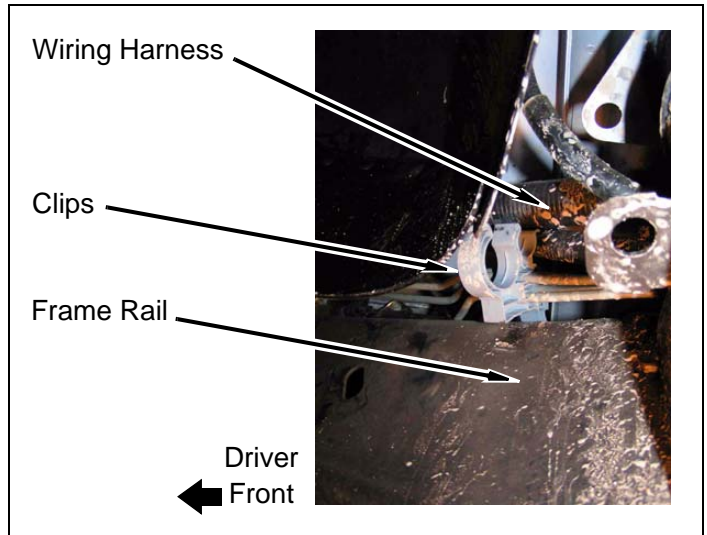

- b. Install wiring harness onto brake line, if possible.

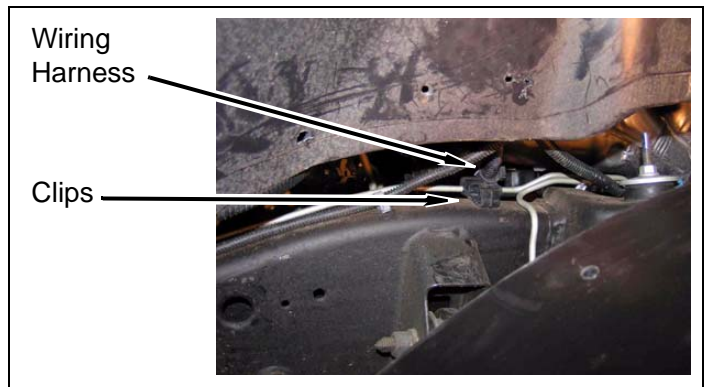

- c. Install wire clips to body and frame rail along passenger side, if possible.

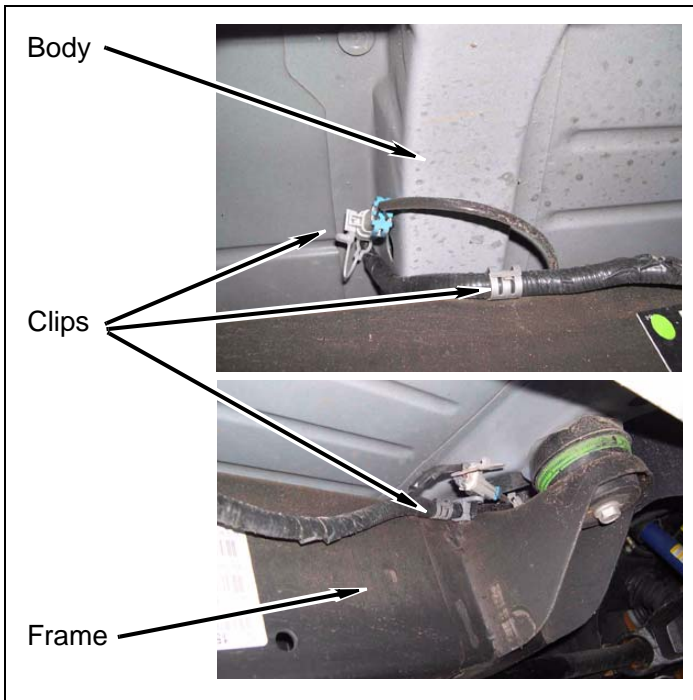

Front of Vehicle

1. Ground straps

- a. Install ground straps to front cab mounting pads using factory bolts.

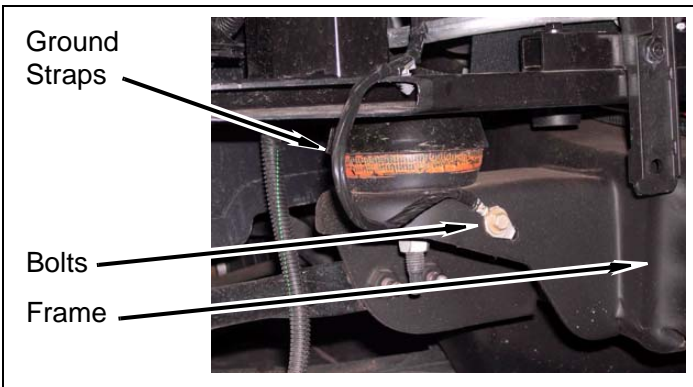

2. Transmission cooler

- a. Remove two clip nuts from top of transmission cooler and install onto core support.

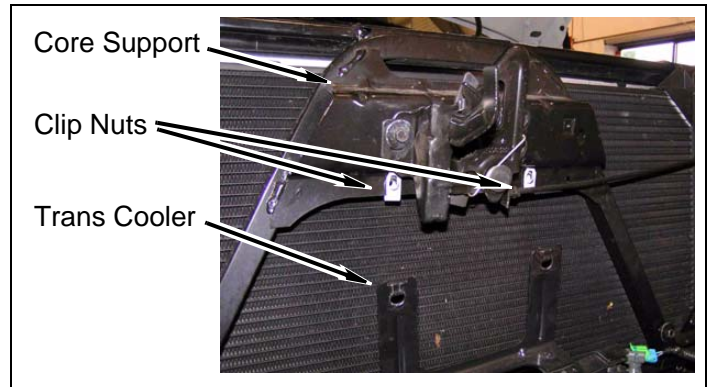

- b. Install two *kit bracket* (2" S-shaped) onto clip nuts on core support with factory bolts. **DO NOT TIGHTEN.**

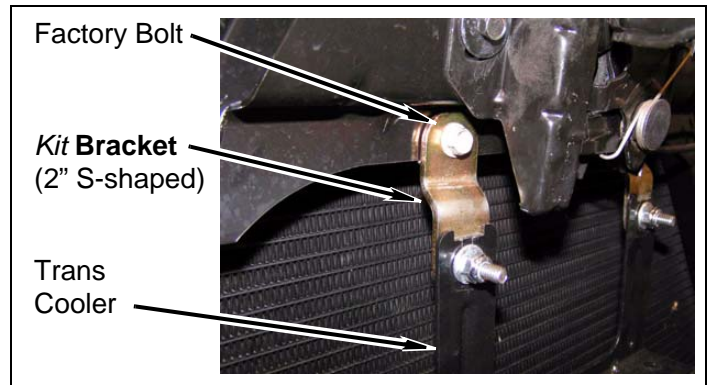

- c. Install transmission cooler on two *kit brackets* (2" S-shaped) with *kit washer* (1/4" SAE) and *kit nut* (1/4"-20 Nylock). **DO NOT TIGHTEN.**

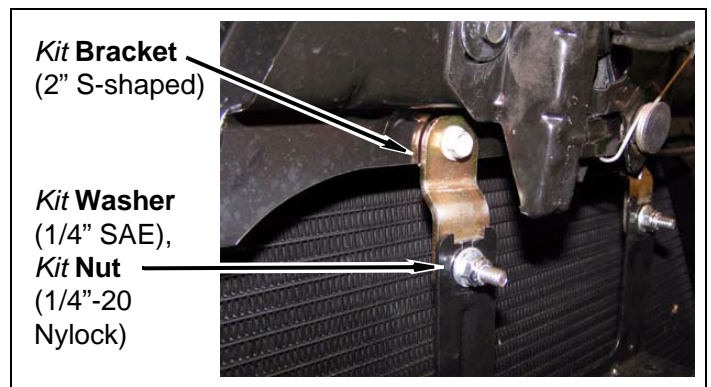

- d. Install transmission cooler to core support bracket with two **kit spacers** (2" x .5 ID x .59 OD) with two **kit bolts** (1/4"-20 x 3"), four **kit washers** (1/4" SAE) and two **kit nuts** (1/4"-20 Nylock). DO NOT TIGHTEN.

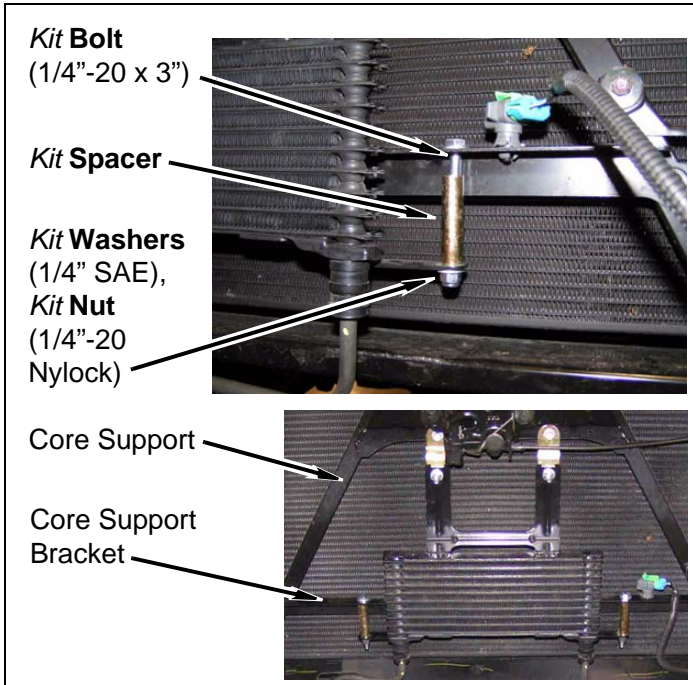

- e. Adjust transmission cooler and position transmission cooler lines in factory clips.

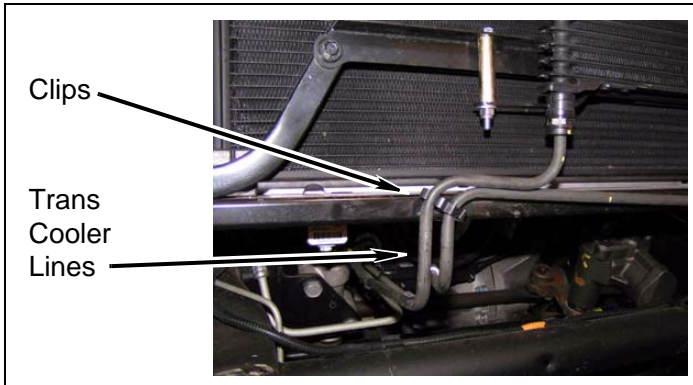

- f. Tighten all hardware.

3. Front bumper

- a. Cut frame rails as shown.

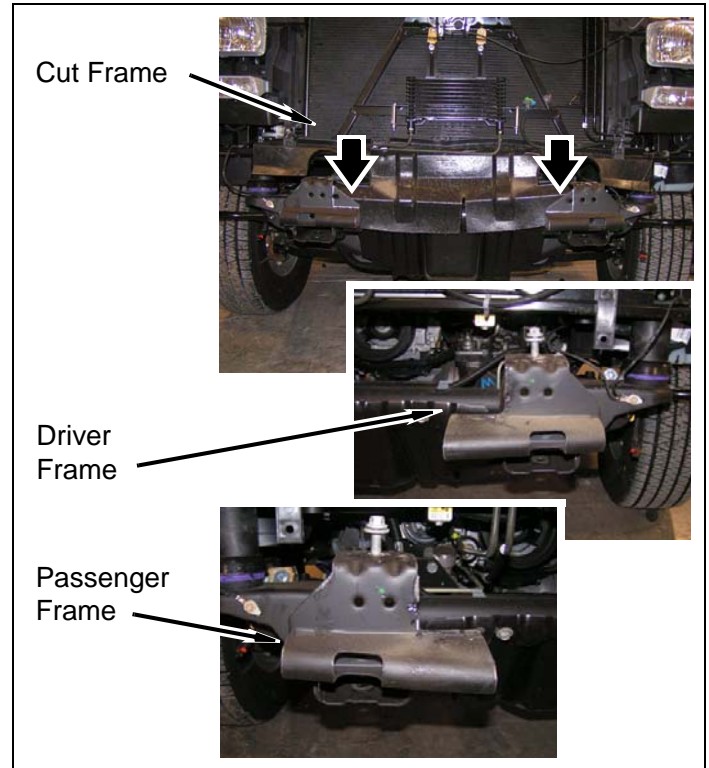

- b. Install **kit bracket** (front bumper, passenger) on frame with factory bolt, **kit bolt** (7/16" x 1-1/2"), two **kit washers** (7/16" USS) and **kit nut** (7/16" Nylock). Apply a few drops of **kit Loctite®** to factory front bumper bolt. DO NOT TIGHTEN.

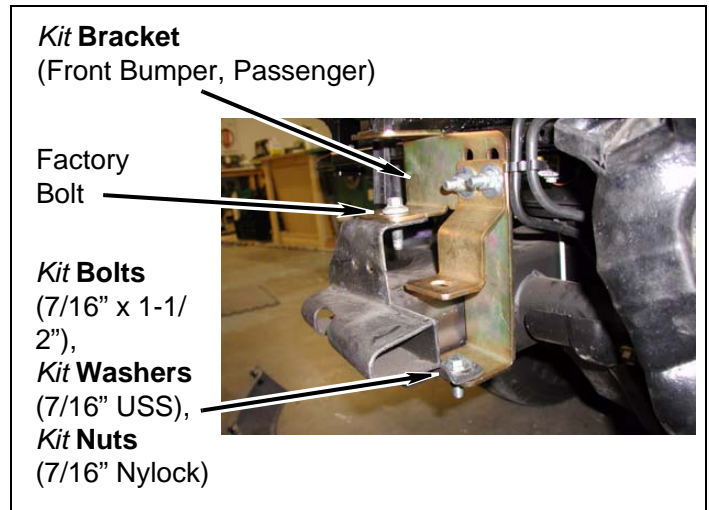

- c. Install *kit bracket* (front bumper, inner passenger) to *kit bracket* (front bumper, passenger) with two *kit bolts* (7/16" x 1-1/2"), four *kit washers* (7/16" USS) and two *kit nuts* (7/16" Nylock). DO NOT TIGHTEN.

- f. Remove pop-ups and valence from front bumper.

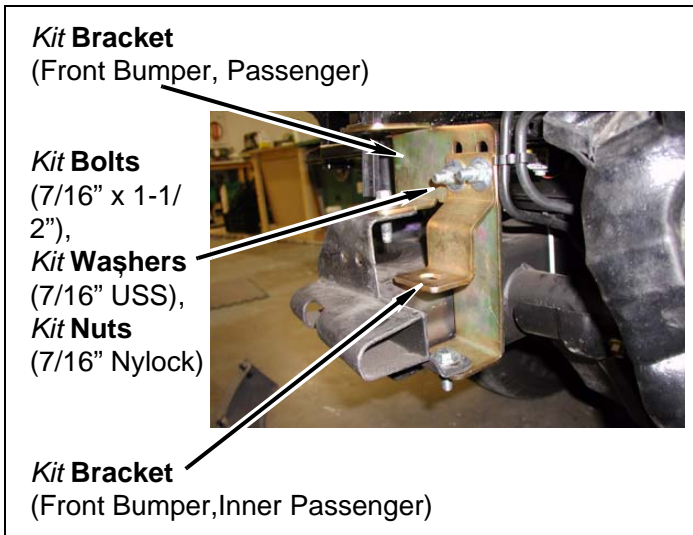

- d. Repeat above steps for driver side of vehicle.
- e. Install air flap with push clips into corresponding holes on core support.

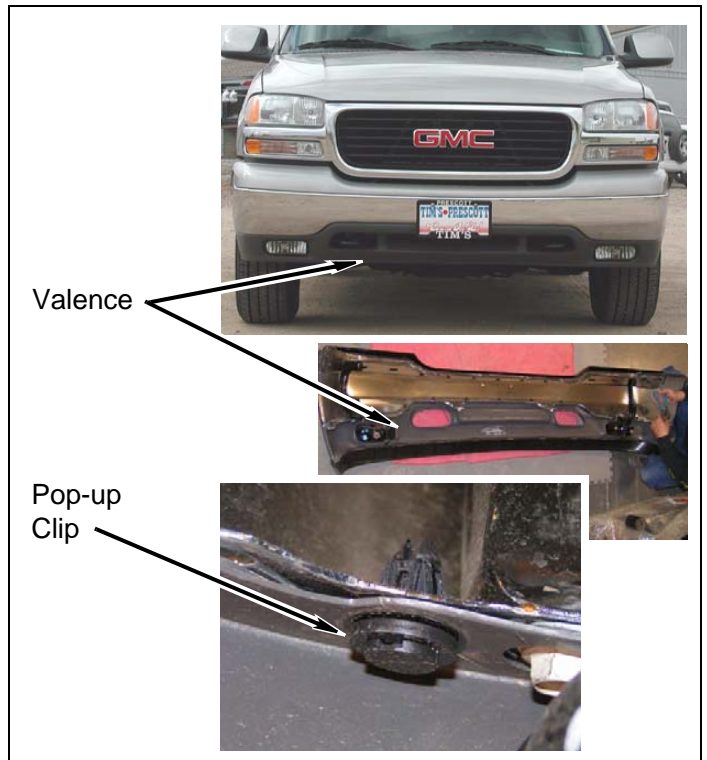
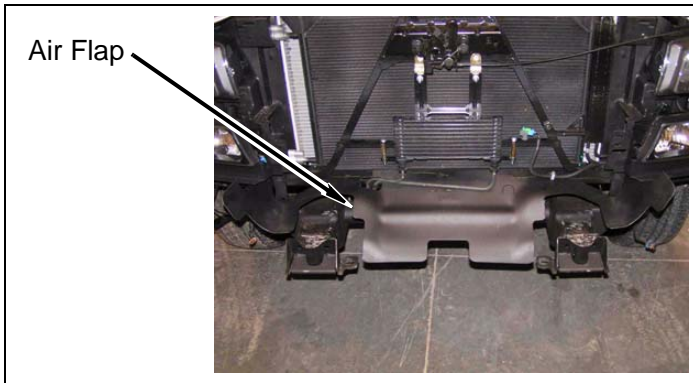

- g. Install front bumper to *kit brackets* (front bumper) and *kit brackets* (front bumper, inner) with two factory bolts, nuts, two *kit bolts* (7/16" x 1-1/2"), four *kit washers* (7/16" USS) and two *kit nuts* (7/16" Nylock). Apply a few drops of *kit Loctite®* to threads of factory bolts. DO NOT TIGHTEN.

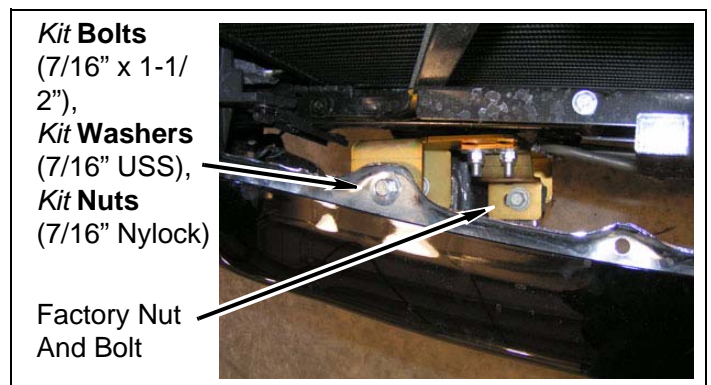

- h. Install **kit bracket** (front bumper, outer) onto passenger side frame with factory bolts. Apply a few drops of **kit Loctite®** to threads of factory bolt. **DO NOT TIGHTEN.**

- i. Install two wire connectors onto fog lamps, if equipped.

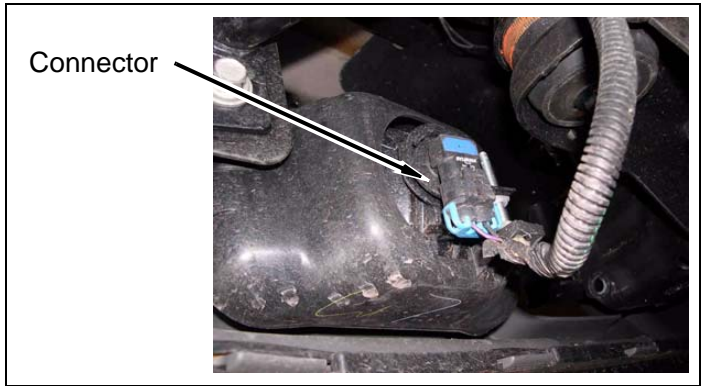
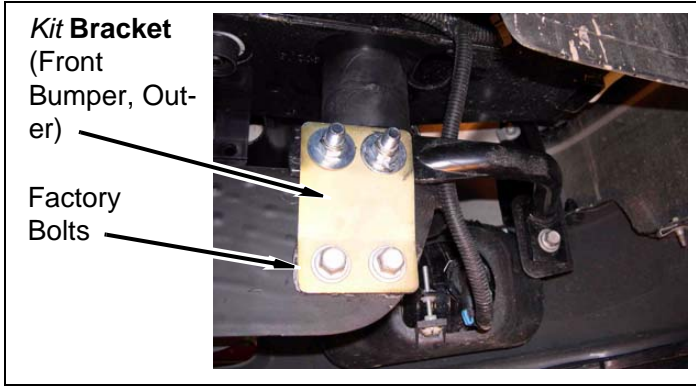

- i. Install front outer bracket to **kit bracket** (front bumper, outer) with two **kit bolts** (7/16" x 1-1/2") four **kit washers** (7/16" USS) and two **kit nuts** (7/16" Nylock). **DO NOT TIGHTEN.**

- m. Adjust bumper-to-fender measurement.

- n. Tighten all hardware.

4. Front bumper valence

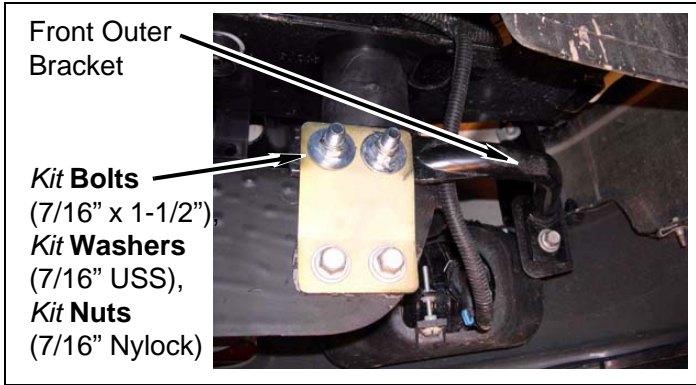

CAUTION

When removing material front the valence it is recommended to trim small amounts. The template provided is a guide. Please proceed cautiously and patiently--many trial fittings may be necessary.

- a. **Chevrolet models:** Position **kit template** (front bumper) on front bumper valence as shown. Mark front bumper valence following kit template outline.

- j. Apply a few drops of **kit Loctite®** to threads of factory bolt. Install front outer bracket to front bumper with factory bolt. **DO NOT TIGHTEN.**

- b. **Chevrolet models:** Trim front bumper valence as shown.

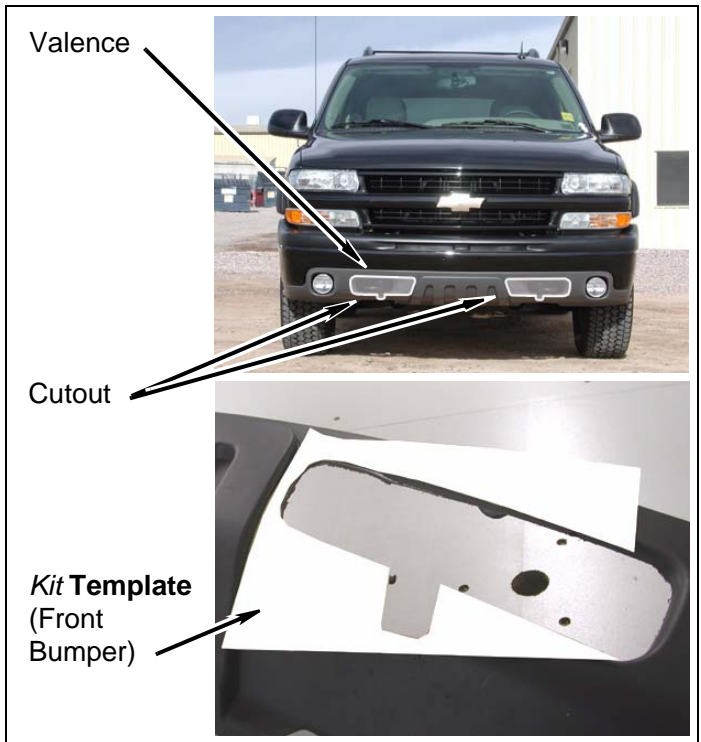
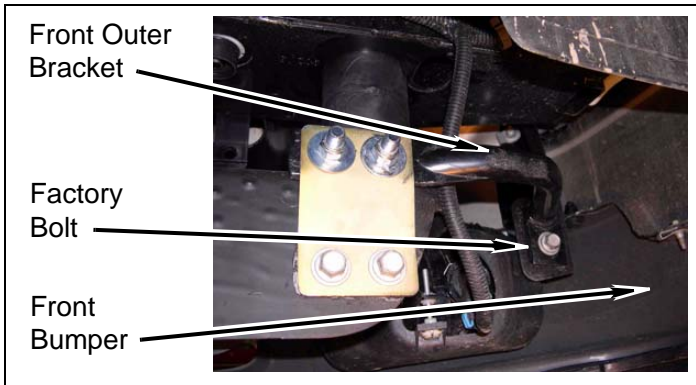

- k. Repeat above steps for driver side of vehicle.

⚠ CAUTION

When removing material from the valence it is recommended to trim small amounts. Please proceed cautiously and patiently--many trial fittings may be necessary.

- c. **GMC models:** Mark driver and passenger side of front bumper valence as shown.

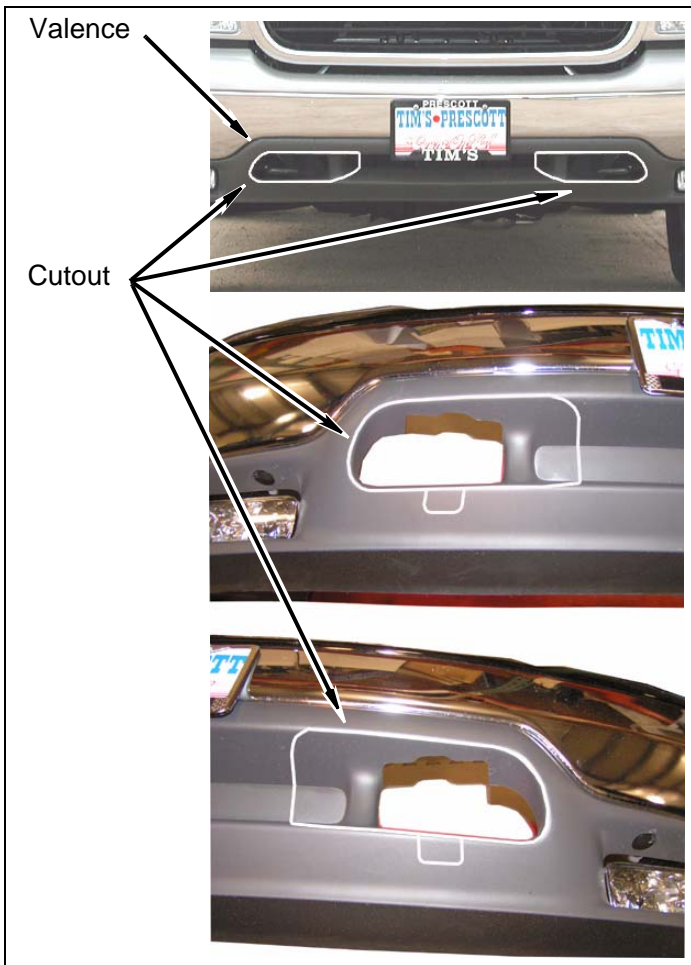

- d. Trim front bumper valence as shown.

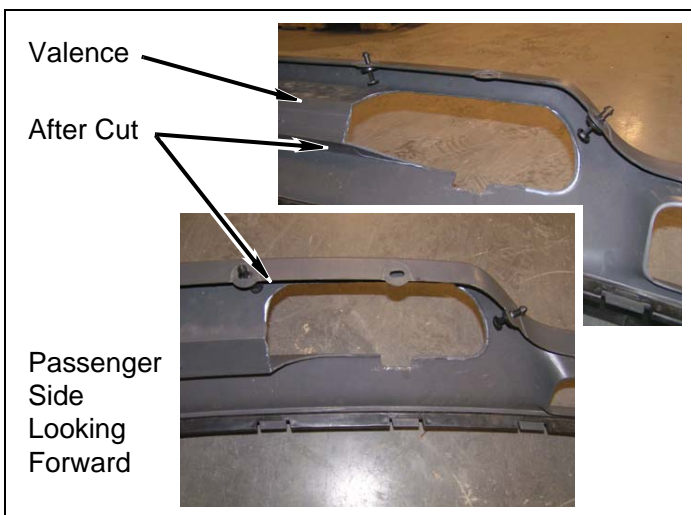

- e. **GMC models without blocked center:** Position two *kit brackets* (valence) on lower valence 7.5" from center. Mark and drill four 1/4" holes in lower valence. Install two *kit brackets* (valence) with four *kit clips* (push).

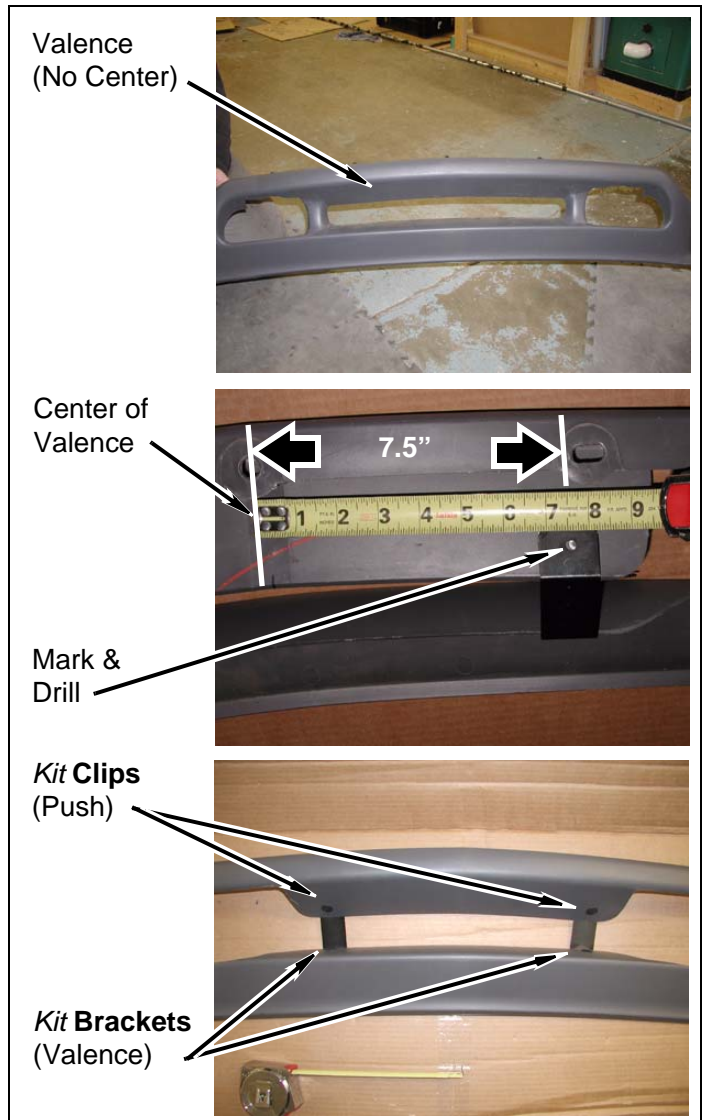

f. If necessary, mark and trim two **kit covers** (valence) with dull finish facing outward. Trim lines to match front bumper curve.

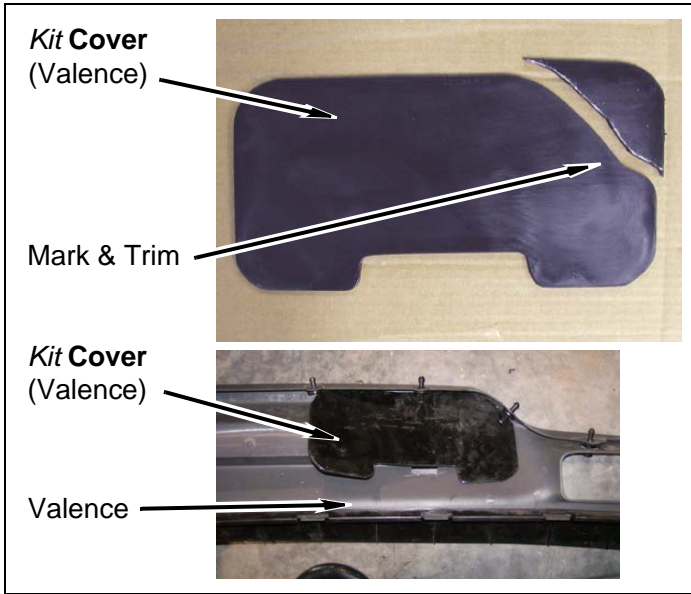

g. Install two tow hooks with factory bolts.

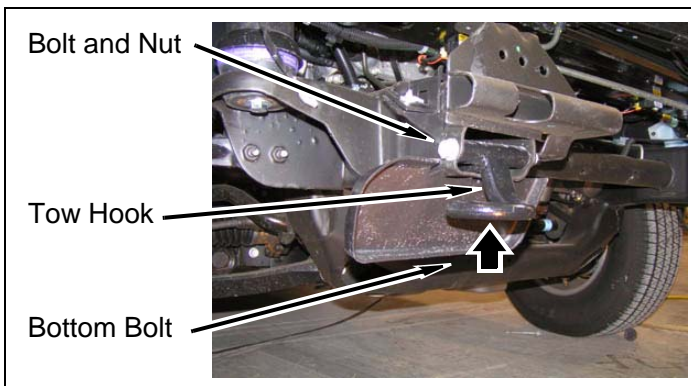

NOTE:
DO NOT INSTALL factory tow hook covers. The tow hook covers will no longer fit.

h. Position front bumper valence and **kit covers** (lower valence) with dull finish facing outwards.

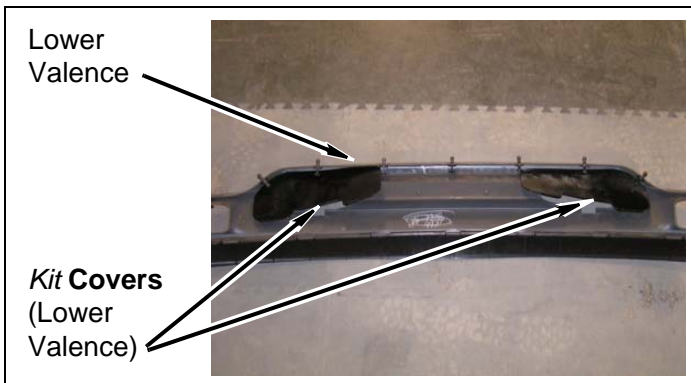

i. Push front bumper valence and **kit covers** onto front bumper with pop-up clips.

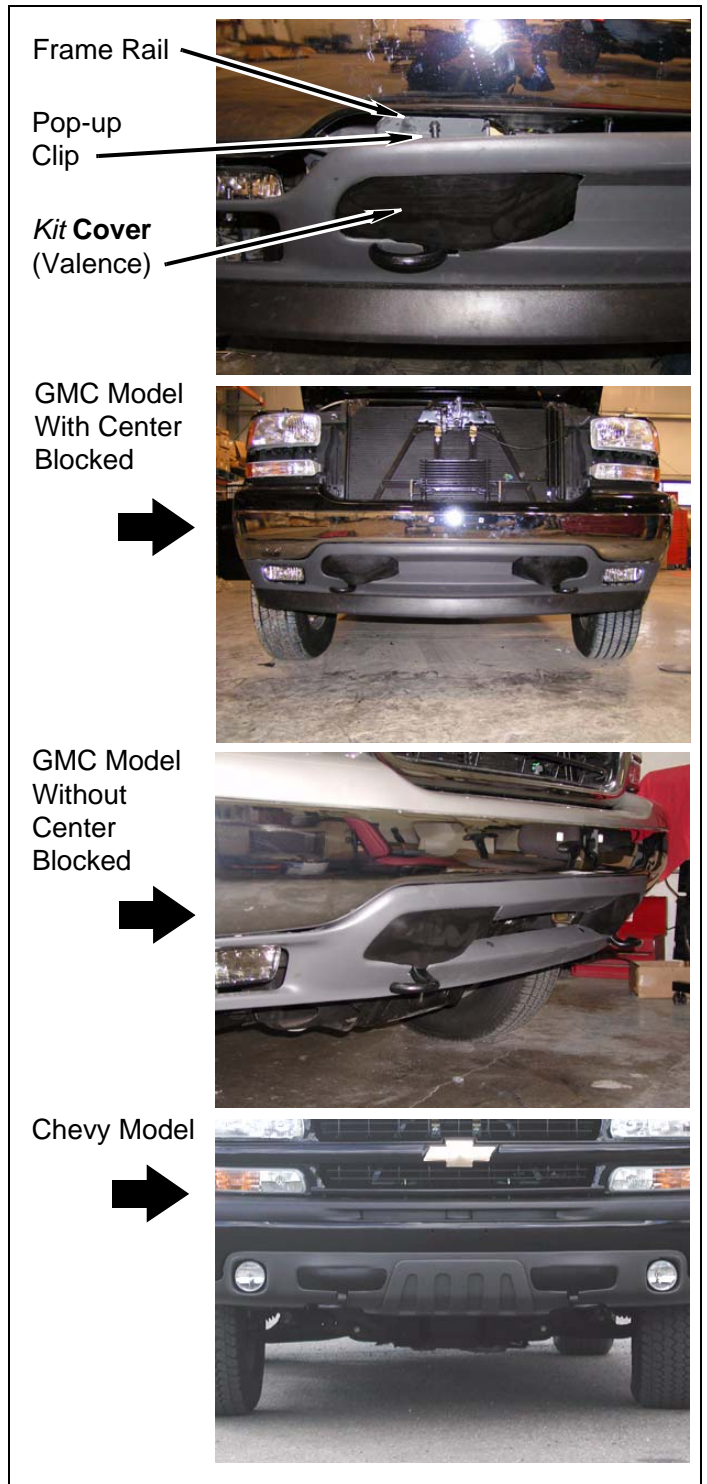

NOTE:
It is helpful when installing the front bumper valence to first install the pop-up clips located over the frame rails.

- j. If necessary, drill two 1/8" holes in **kit covers** (valence) to left and right of tow hook. Install **kit tie** (zip) through two drilled holes around tow hook.

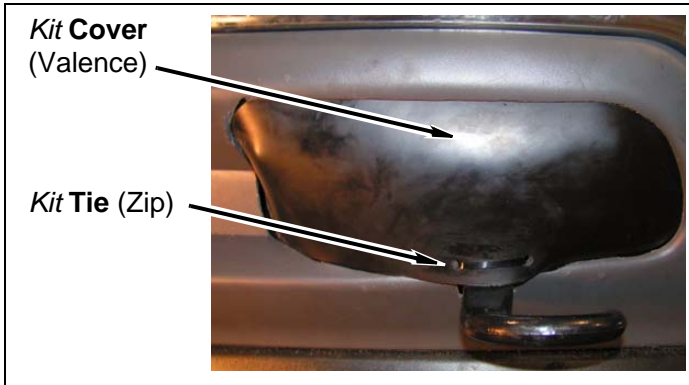

- k. Install lower guard to core support and frame with factory bolts.

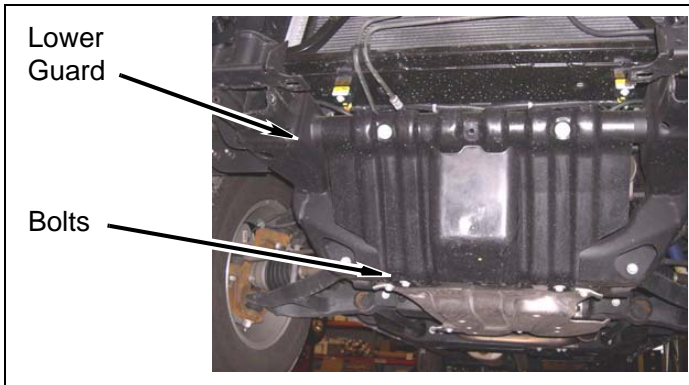

- a. Install **kit extension** (steering) in position on upper steering shaft with **kit bolt** (3/8" x 1-3/4"), two **kit washers** (3/8" SAE) and **kit nut** (3/8" Nylock). DO NOT TIGHTEN. Ensure marks on upper steering shaft and lower steering shaft are aligned.

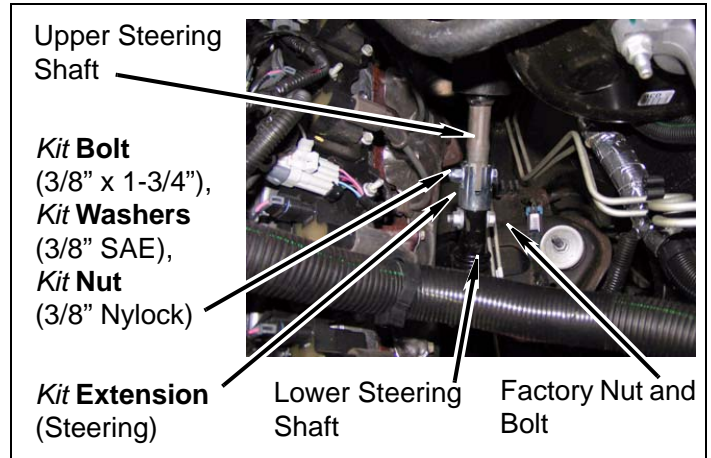

- b. Install lower steering shaft on **kit extension** (steering) with factory bolt and nut, ensuring marks on upper steering shaft and lower steering shaft are aligned. DO NOT TIGHTEN.
- c. Apply a few drops of Loctite® to threads of factory bolt and **kit bolt** (3/8" x 1-3/4").
- d. Install and tighten bolts.

Engine Compartment

1. Steering shaft



⚠ WARNING

Verify the steering extension is securely installed as specified in the instructions. Failure to do so may cause steering malfunction, resulting in property damage or serious personal injury.

2. Ground strap

- a. Install **kit bracket** (ground strap) to factory post with factory nut. Install ground strap to **kit bracket** (ground strap) with **kit bolt** (1/4"-20 x 1"), two **kit washers** (1/4" SAE) and **kit nut** (1/4"-20 Nylock).

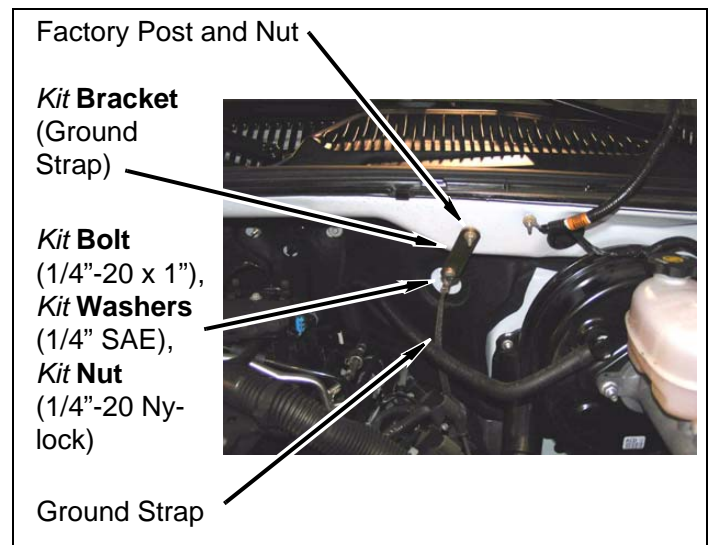

3. **Electric fan:** Radiator

- a. No procedures required.

4. **Mechanical fan:** Radiator

- a. Assemble **kit plate** (left block off), **kit plate** (middle block off) and **kit plate** (right block off), ensuring lip of each **kit plate** is aligned with other **kit plates**.

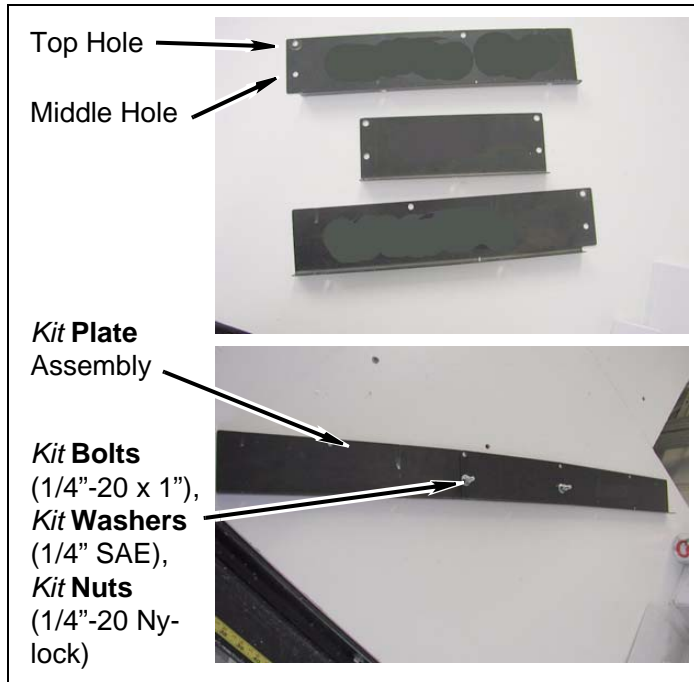

- b. Install **kit plates** with two **kit bolts** (1/4"-20 x 1"), four **kit washers** (1/4" SAE) and two **kit nuts** (1/4" nylock). DO NOT TIGHTEN.

NOTE:

2" Kit: When installing **kit plates** on core support, use four top holes. The two middle holes are for **kit loom** (wire) and pre-assembly.

3" Kit: When installing **kit plates** on core support, use two middle holes and install two **kit loom** (wire) in same location.

- c. Position two **kit loom** (wire) on wiring harness as shown.

- d. Position **kit plate** assembly and two **kit loom** (wire) on core support with four **kit bolts** (1/4"-20 x 1"), four **kit washers** (1/4" SAE) and four **kit nuts** (1/4" nylock). DO NOT TIGHTEN. Ensure lip of **kit plate** assembly is pointing forward as shown.

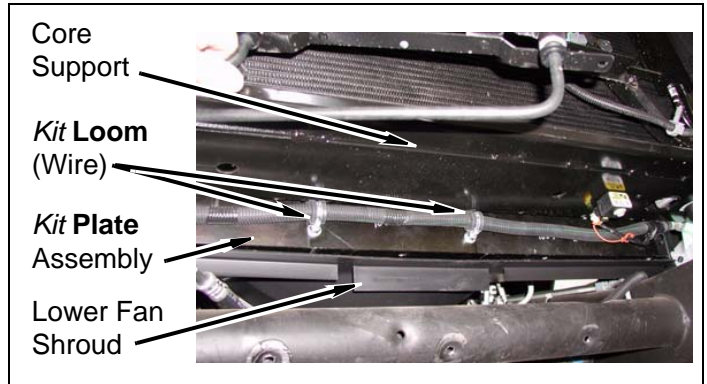

- e. Position fan on fan clutch with four bolts. DO NOT TIGHTEN.

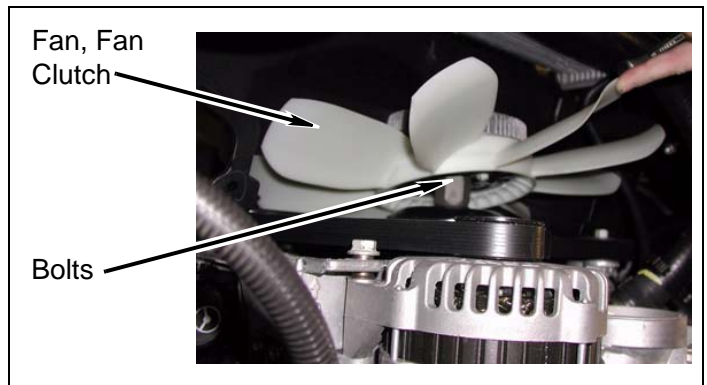

NOTE:

For easier positioning of lower **kit plate** assembly to lower fan shroud:

1. Install **kit brackets** (radiator) on upper fan shroud.
2. Install upper fan shroud along with lower fan shroud to core support.

- f. Position and center lower fan shroud on **kit plate** assembly. Mark position of lower fan shroud **kit plate** assembly in relation to lower fan shroud. Ensure lower fan shroud will not come in contact with fan.

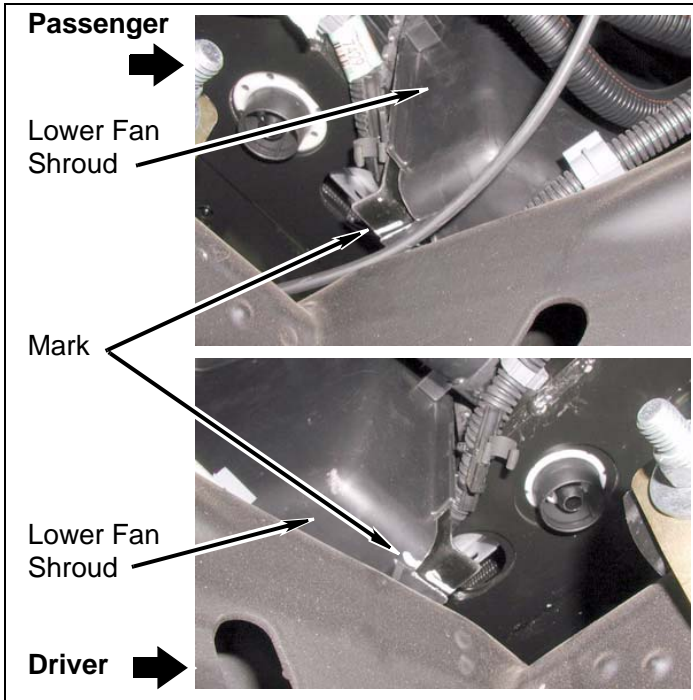

- g. Remove four bolts and fan from fan clutch. Rest fan on fan clutch shaft.

NOTE:
 For assistance holding **kit plate** assembly square, install a second **kit bolt** (1/4"-20 x 1") to the **kit plate** assembly.

- h. Remove lower fan shroud and **kit plate** assembly from vehicle and position together as shown. Continue marking fan shroud as shown. Trim fan shroud where marked.

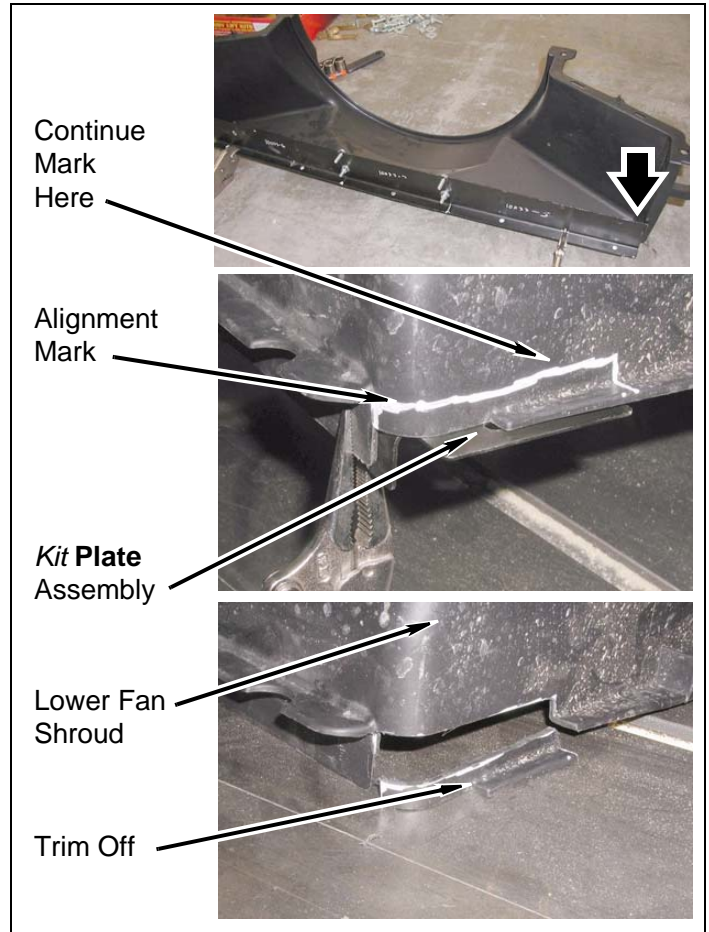

- i. Position lower fan shroud and **kit plate** assembly together as marked. Using **kit plate** assembly as a template, drill five 1/4" holes.

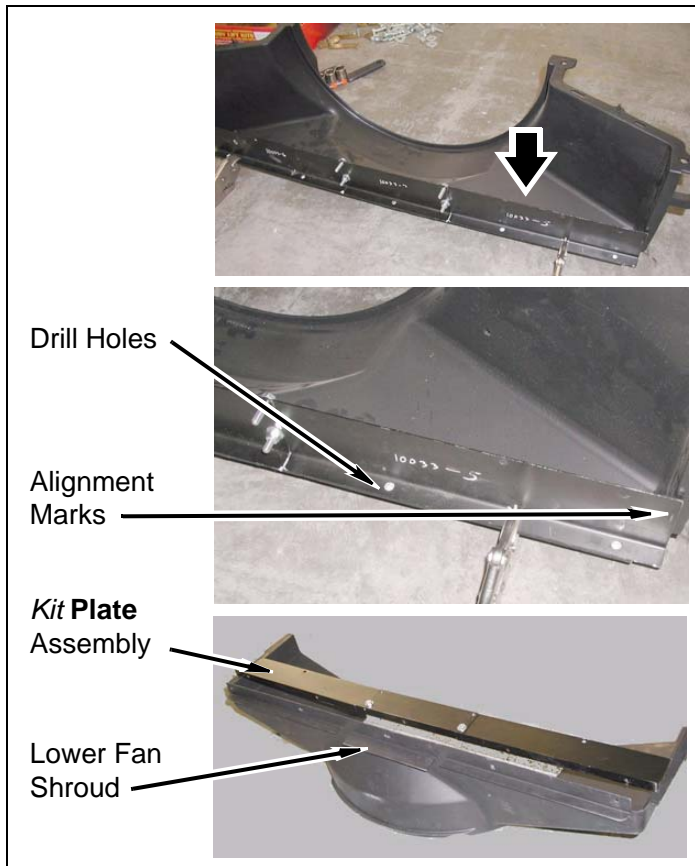

- j. Trim locking tabs and marked edges from driver and passenger fan shroud as shown.

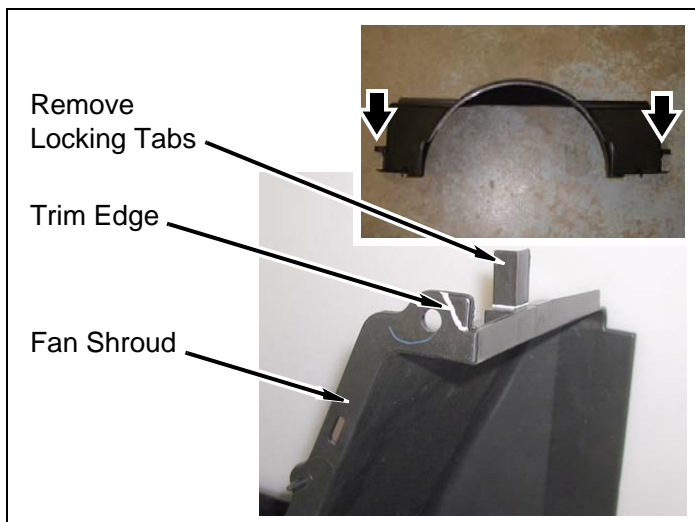

- k. Using lower fan shroud as a template, mark upper fan shroud. Trim marked edges from upper fan shroud to coincide with lower fan shroud as shown.

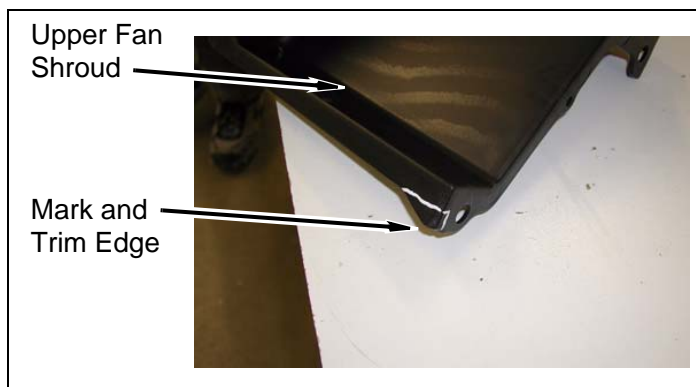

- l. Position and rest lower fan shroud in engine compartment.

- m. Install **kit plate** assembly and two **kit loom** (wire) on core support with four **kit bolts** (1/4"-20 x 1"), four **kit washers** (1/4" SAE) and four **kit nuts** (1/4" nylock).

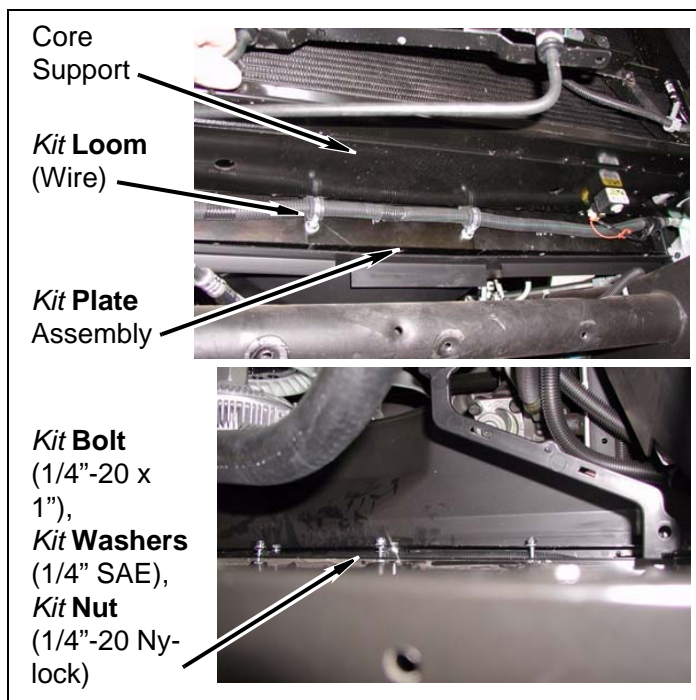

- n. Install lower fan shroud on **kit plate** assembly with three **kit bolts** (1/4"-20 x 1"), six **kit washers** (1/4" SAE), three **kit nuts** (1/4" nylock) and two **kit clips** (push).

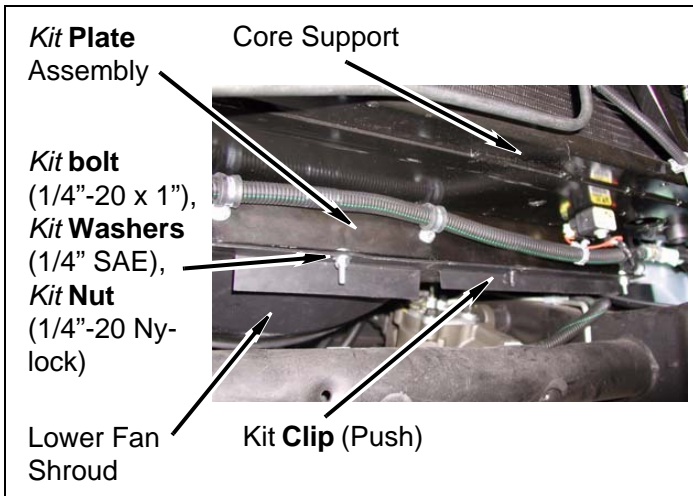

- o. Install fan on fan clutch with four bolts.
- p. **2" kit**: trim upper lip from upper fan shroud as shown.

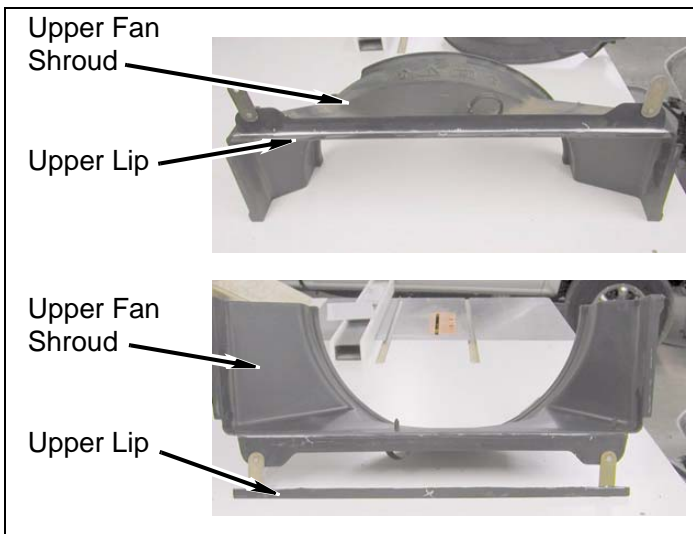

- q. Remove two bolts from radiator and upper core support.

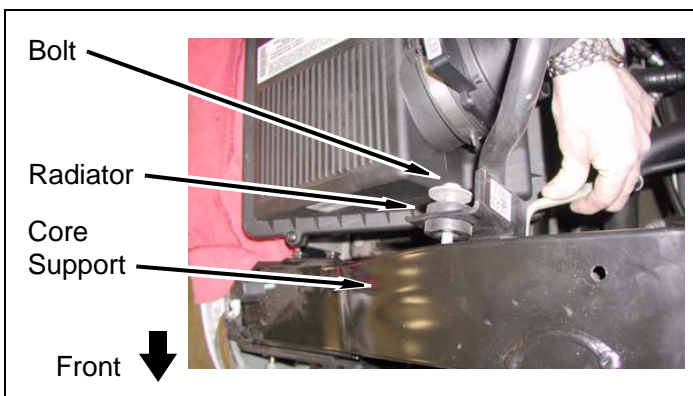

- r. Assemble **kit cover** (upper fan shroud block off), upper fan shroud and two **kit brackets** (radiator) with two **kit washers** (1/4" SAE) and two **kit nuts** (1/4" nylock).
- s. Drill upper fan shroud using **kit cover** (upper fan shroud block off) as a template. Drill with a 1/4" drill bit and install a **kit clip** (push) as shown with a **kit washer** (1/4" SAE).

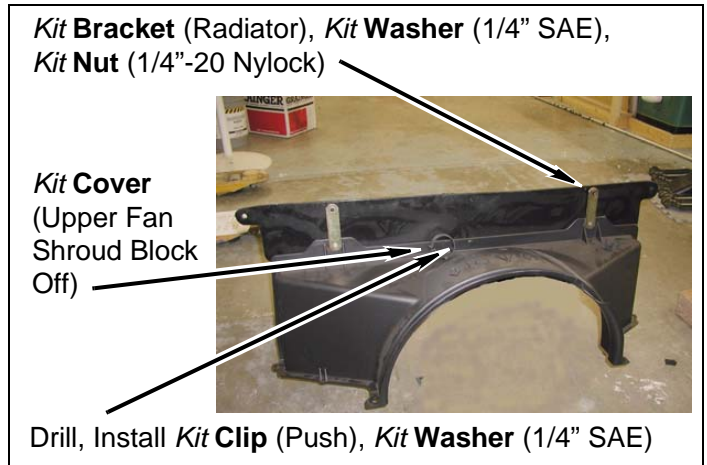

- t. Install upper fan shroud assembly on core support, radiator and lower fan shroud with four bolts. Ensure **kit cover** (upper fan shroud block off) is placed in between core support and radiator.

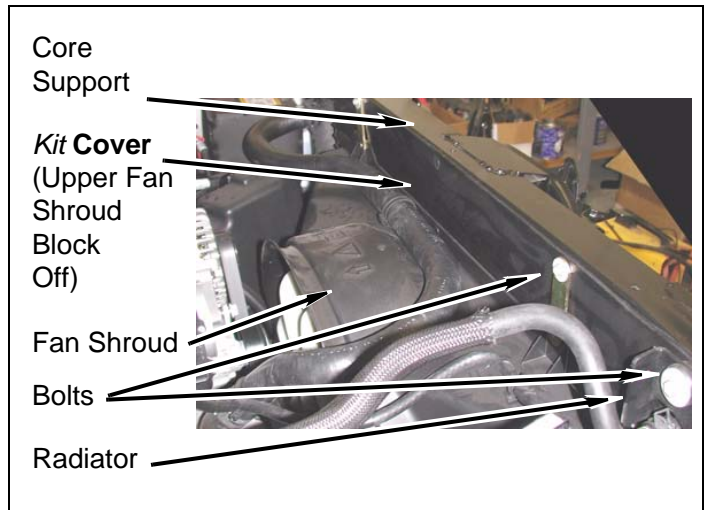

- u. Attach upper fan shroud to lower fan shroud with four pop-ups on sides of fan shroud.

NOTE:
Ensure all safety and care precautions are taken when operating power tools.

- v. Using **kit cover** (upper fan shroud block off) as a template, drill a 1/4" hole in core support and install a **kit clip** (push) as shown.

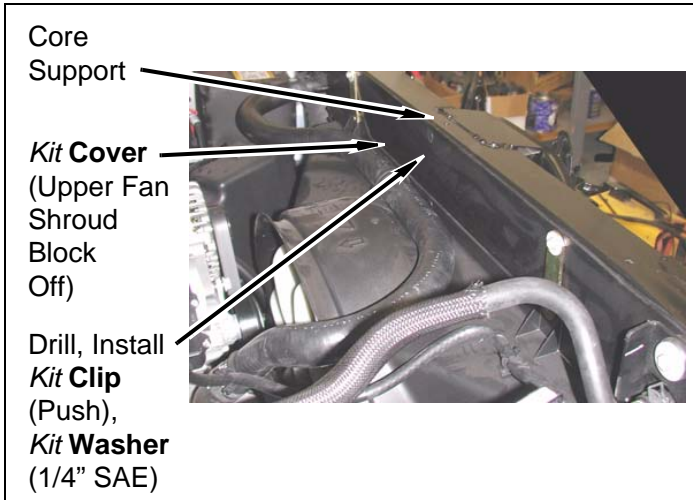

- w. Check fan to fan shroud clearance. Ensure gap is uniform around shroud and tighten all nuts and bolts.

5. Engine

- a. Position engine air intake hose on throttle body and airbox.

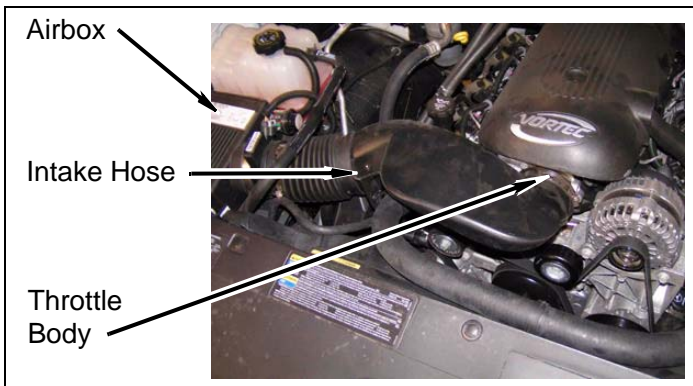

- b. Install radiator hoses to engine air intake hose with clips.

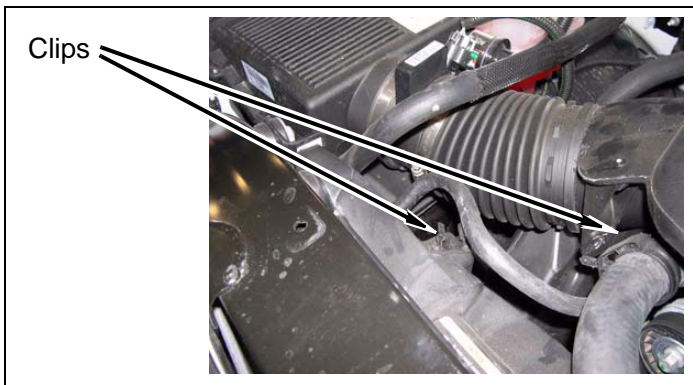

- c. Tighten engine air intake hose clamps.

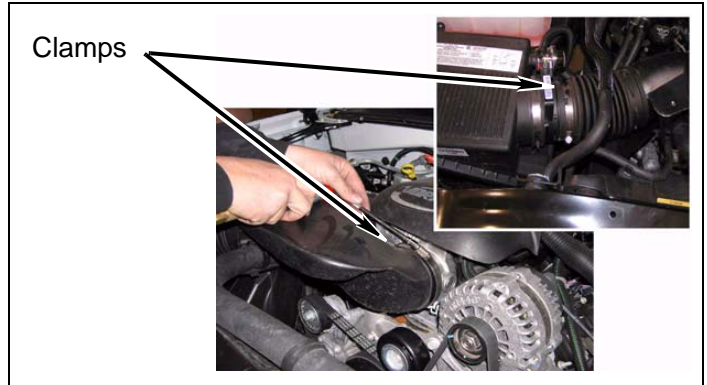

- d. Install engine cover and factory bolt to engine.

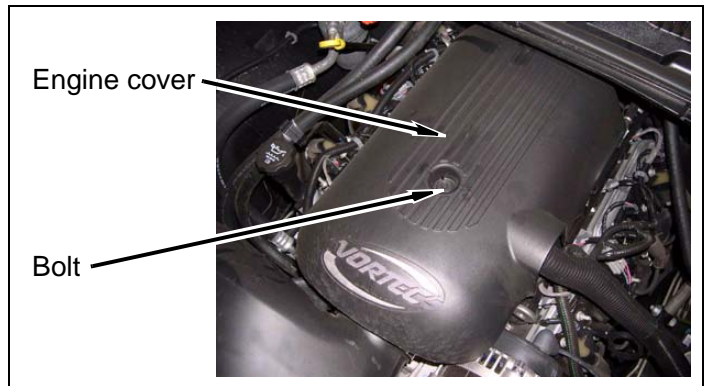

- e. Install radiator hose to radiator with clip.

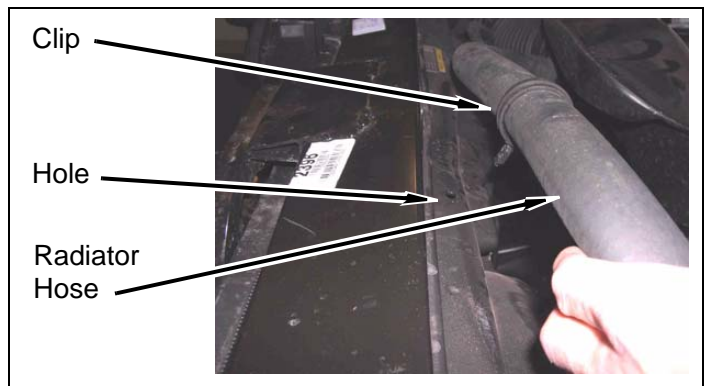

- f. Install heater hoses into clip.

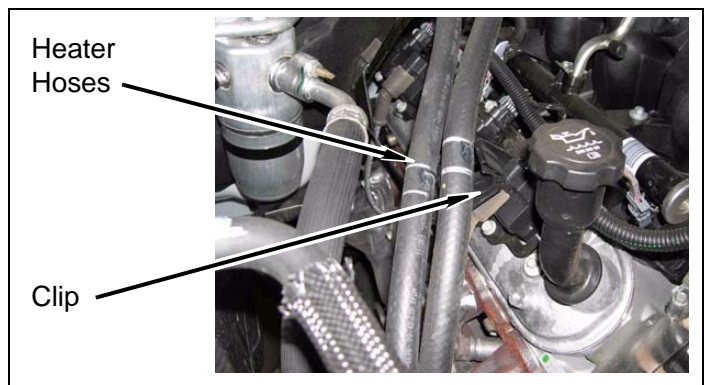

- g. Install wiring harness into wire clip on driver side.

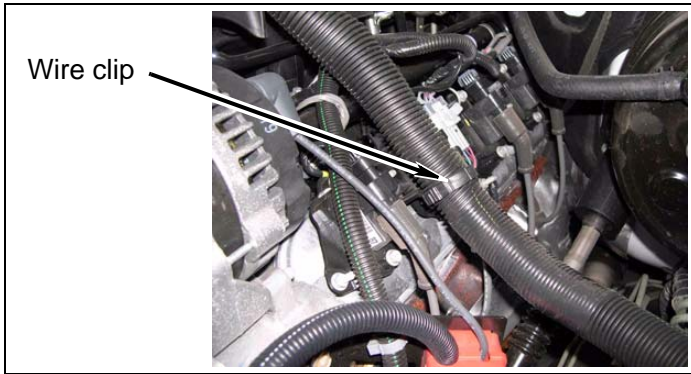

- h. Install wire harness onto three clips near brake lines on driver side.

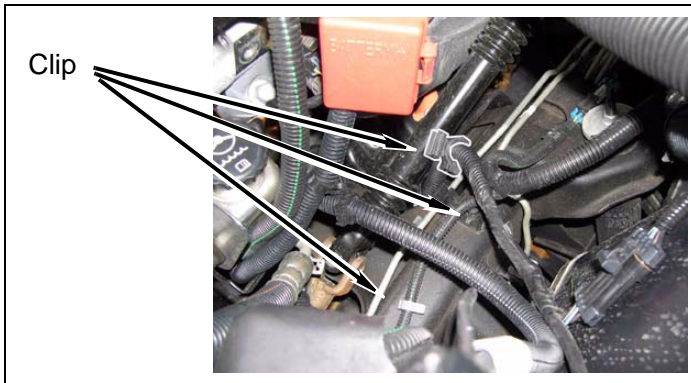

After Completing Installation

Engine Compartment

- 1. Install airbag fuse and fuse block cover.

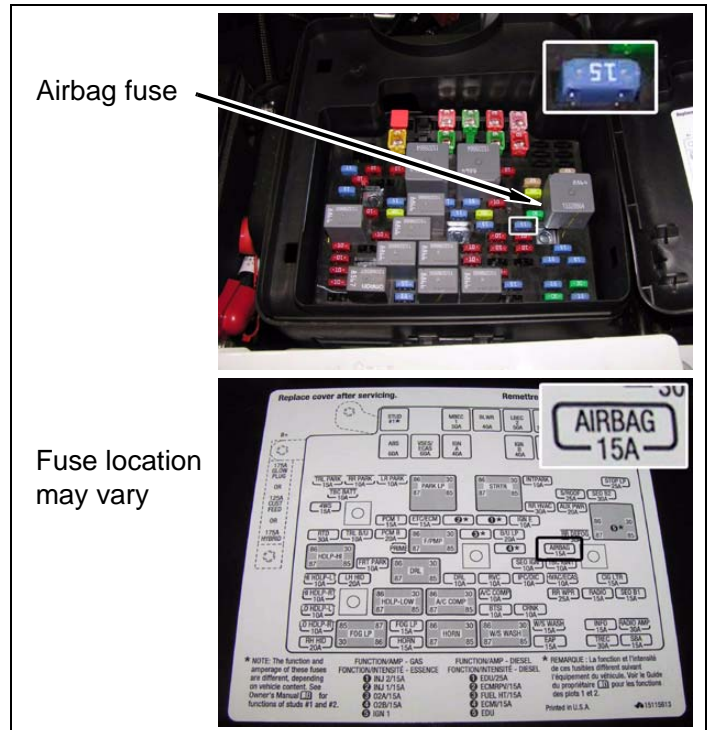

- 2. Connect both battery cables. Connect positive cable first, then negative cable.

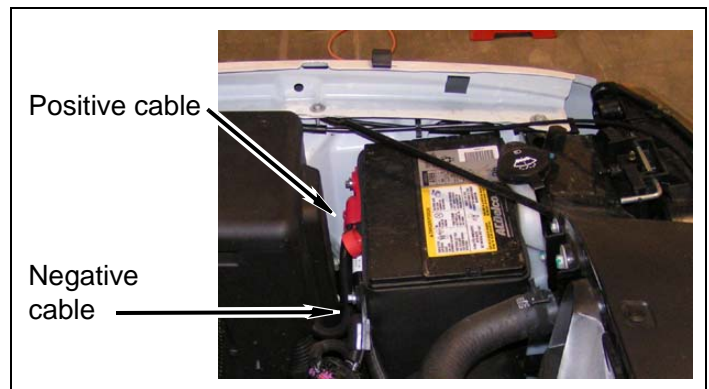

Miscellaneous

- 1. Apply **kit label** (warning) to dashboard in plain sight of all vehicle occupants.
- 2. Check all fasteners to ensure they are tight.
- 3. Ensure all wires, hoses, cables, etc. are properly connected and there is ample slack.

Dynamic Vehicle Check

1. Check steering in both directions to ensure that there is no bind. Check operation of clutch, brake system, and parking brake. Check operation of transmission and transfer case. Ensure there is full engagement in all gears and 4WD ranges. Check battery connections and electrical component operations. Test-drive vehicle.

⚠WARNING

Retorque all fasteners after 500 miles and after off road use. All body lift components should be visually inspected and fasteners retorqued during routine vehicle servicing.

⚠CAUTION

Performance Automotive Group does not recommend any particular wheel and tire combinations for use with its body lifts and cannot assume responsibility for the customer's choice of wheels and tires. Refer to your owner's manual for recommended tire sizes and warnings related to the use of oversized tires. Larger wheel and tire combinations increase stress and wear on steering and suspension components, which leads to increased maintenance and higher risk for component failure. Larger wheel and tire combinations also alter speedometer calibration, braking effectiveness, center of gravity, and handling characteristics. Consult an experienced local off road shop to find what wheel and tire combinations work best with your vehicle.

⚠NOTE

All warranty information, instruction sheets, and other documents regarding the installation of this product must be retained by the vehicle owner. Information contained in the instructions and on the warranty card will be required for any warranty claims. The vehicle owner needs to understand the modifications made to the vehicle and how they affect vehicle handling and performance. Failure to provide the customer with this information can result in damage to the vehicle and severe personal injury.

Accessories

The following accessories are also available:

Kit # 6542: Gap Guards



Template #1

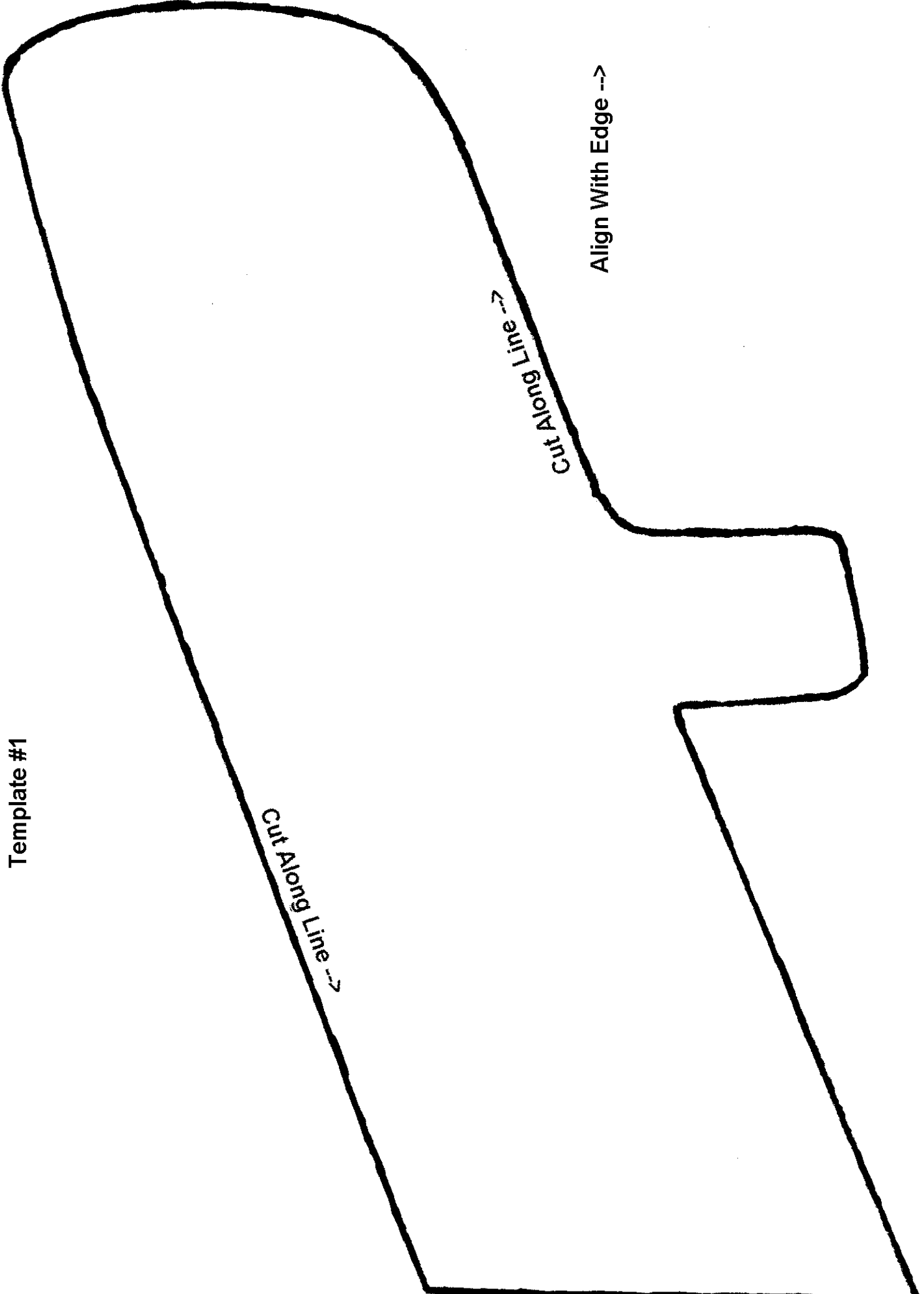

Cut Along Line -->

Cut Along Line -->

Align With Edge -->

Kit Parts List

Qty.	Description
12	Block , 3" x 3" spacer
11	Bolt , 1/4"-20 x 1"
2	Bolt , 1/4"-20 x 3"
2	Bolt , 3/8"-16 x 1-1/2"
1	Bolt , 3/8"-16 x 1-3/4", hex head
3	Bolt , 5/16" x 1"
24	Bolt , 7/16" x 1-1/2"
1	Bolt , 8mm x 70mm
12	Bolt , 12mm-1.75 x 180mm
2	Bolt , 14mm-2.0 x 110mm
2	Bracket , 3" radiator
2	Bracket , 2" S-shaped
1	Bracket , front bumper, driver
1	Bracket , front bumper, passenger
2	Bracket , front bumper, inner
2	Bracket , front bumper, outer
1	Bracket , ground strap
1	Bracket , parking brake
1	Bracket , rear bumper, driver
1	Bracket , rear bumper, passenger
2	Bracket , trailer hitch
5	Clip , push
2	Cover , front bumper valence (urethane)
1	Cover , upper fan shroud block off (urethane)
1	Extension , steering
1	Label , logo
1	Label , warning
1	Label , warning, rear bumper
1	Loctite ®, 6ml bottle
2	Loom , wire
17	Nut , 1/4" nylock
2	Nut , 14mm nylock
4	Nut , 3/8" nylock
3	Nut , 5/16" nylock
24	Nut , 7/16" nylock
1	Plate , left block off
1	Plate , middle block off
1	Plate , right block off
3	Spacer , 2" x .5" ID x .59" OD
3	Tie , zip

Qty.	Description
2	Washer , 1/2" thick
28	Washer , 1/4" SAE
2	Washer , 14mm
4	Washer , 3/8" USS
2	Washer , 3/8" SAE
6	Washer , 5/16" USS
60	Washer , 7/16" USS
2	Washer , square, 3/16" x 1-1/2" x 2-1/2"
1	Washer , 8mm

⚠ NOTE

Depending on the vehicle configuration (automatic or manual transmission, 2WD or 4WD, cab length, bed length, etc.), model year, some parts may not be used.